

# DESIGNER METALS

---

*from concept to completion*

One must dare to explore the depth of each layer of the design process, this is how we create works of pure brilliance.

Take a look at our design process and you will see no detail left unnoticed. We start on paper and take from our extensive research to create bold lines and unique textures. We play with combining different materials to evoke visual interest. Pair that with our striking finishes in polished, brushed and matte textures and you get sophisticated styles crafted with care.





# CONTENTS

06	Overview
08	1" Finials & Components
17	1 $\frac{3}{8}$ " Finials & Components
37	2" Finials & Components
44	Helpful Guides
44	AMP™ Motorization
46	Estate™ Overview
48	Bracket Spacing & Mount Option
52	Calculating Drapery Weight
53	Stack Guides
60	1 $\frac{3}{8}$ " Decorative Bracket Weight Chart
61	Pole Installation, Cutting & Splicing
62	Complete Collection Overview
64	Index



# COLLECTION OVERVIEW

8

## FINISHES

A dazzling assortment of light and dark

3

## VERSATILE SIZES

1", 1 $\frac{3}{8}$ " & 2"

2

## ESTATE™ TRAVERSE ROD SIZES

1 $\frac{3}{8}$ " & 2"

1

## BRILLIANT COLLECTION

### ARCHITRAC™ K-RAIL COMPATIBLE

1 $\frac{3}{8}$ " finials only

### AMP™ MOTORIZATION COMPATIBLE

Estate™ Traverse Rods only

4

7

1 | Elegant Brass

2 | Antique Silver

3 | Gunmetal

4 | Black

5 | Polished Nickel

6 | Brushed Bronze

7 | Gilded Bronze

8 | Satin Nickel

1



2



3



5

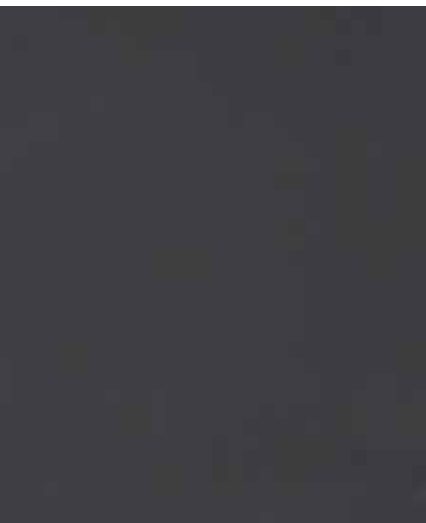

6



8



# 1" Finials

## Fitz



Fits	Dimensions	Quantity per Box
1" Designer Metals™ Poles	Depth: 3/4" Height: 1 1/32" Width: 1 1/32"	4 pairs per box

Product Number & Finish					
1042991	Antique Silver	1042997	Elegant Brass	1042995	Polished Nickel
1042992	Black	1042994	Gilded Bronze	1042996	Satin Nickel
1042993	Brushed Bronze	1042999	Gunmetal		

## Gavin



Fits	Dimensions	Quantity per Box
1" Designer Metals™ Poles	Depth: 2 10/16" Height: 1 1/32" Width: 1 1/32"	4 pairs per box

Product Number & Finish					
1043033	Antique Silver	1043039	Elegant Brass	1043037	Polished Nickel
1043034	Black	1043036	Gilded Bronze	1043038	Satin Nickel
1043035	Brushed Bronze	1043040	Gunmetal		

## Maxwell



Fits	Dimensions	Quantity per Box
1" Designer Metals™ Poles	Depth: 2" Height: 2" Width: 2"	4 pairs per box

Product Number & Finish					
1043000	Antique Silver	1043006	Elegant Brass	1043004	Polished Nickel
1043001	Black	1043003	Gilded Bronze	1043005	Satin Nickel
1043002	Brushed Bronze	1043007	Gunmetal		

## Maxwell - Duotone



Fits	Dimensions	Quantity per Box
1" Designer Metals™ Poles	Depth: 2" Height: 2" Width: 2"	4 pairs per box

Product Number & Finish					
1043043	Black + Brushed Bronze				
1043044	Black + Satin Nickel				



# 1" Finials

## Milo



Fits	Dimensions	Quantity per Box
1" Designer Metals™ Poles	Depth: 2 1/16" Height: 2 1/32" Width: 2 1/32"	4 pairs per box

Product Number & Finish					
<b>1043008</b>	Antique Silver	<b>1043014</b>	Elegant Brass	<b>1043012</b>	Polished Nickel
<b>1043009</b>	Black	<b>1043011</b>	Gilded Bronze	<b>1043013</b>	Satin Nickel
<b>1043010</b>	Brushed Bronze	<b>1043015</b>	Gunmetal		

## Soren



Fits	Dimensions	Quantity per Box
1" Designer Metals™ Poles	Depth: 2 1/2" Height: 2 1/32" Width: 2 1/32"	4 pairs per box

Product Number & Finish					
<b>1043016</b>	Antique Silver	<b>1043022</b>	Elegant Brass	<b>1043020</b>	Polished Nickel
<b>1043017</b>	Black	<b>1043019</b>	Gilded Bronze	<b>1043021</b>	Satin Nickel
<b>1043018</b>	Brushed Bronze	<b>1043023</b>	Gunmetal		

## Turin



Fits	Dimensions	Quantity per Box
1" Designer Metals™ Poles	Depth: 3 1/2" Height: 1 3/4" Width: 1 3/4"	4 pairs per box

Product Number & Finish					
<b>1043025</b>	Antique Silver	<b>1043031</b>	Elegant Brass	<b>1043029</b>	Polished Nickel
<b>1043026</b>	Black	<b>1043028</b>	Gilded Bronze	<b>1043030</b>	Satin Nickel
<b>1043027</b>	Brushed Bronze	<b>1043032</b>	Gunmetal		



1" Fitz | Black, Antique Silver, Brushed Bronze, Gunmetal, Elegant Brass, Gilded Bronze, Satin Nickel, Polished Nickel



Emerson | Gilded Bronze  
Elegant Brass

# 1" Stationary Poles

## 4' Fixed Width Pole



Diameter	Length	Quantity per Box
1"	4'	9 pieces per box

### Product Number & Finish

<b>1042663</b>	Antique Silver	<b>1042669</b>	Elegant Brass	<b>1042667</b>	Polished Nickel
<b>1042664</b>	Black	<b>1042666</b>	Gilded Bronze	<b>1042668</b>	Satin Nickel
<b>1042665</b>	Brushed Bronze	<b>1042670</b>	Gunmetal		

Finial plugs included.  
Brackets sold separately.

## 6' Fixed Width Pole



Diameter	Length	Quantity per Box
1"	6'	9 pieces per box

### Product Number & Finish

<b>1042671</b>	Antique Silver	<b>1042677</b>	Elegant Brass	<b>1042675</b>	Polished Nickel
<b>1042672</b>	Black	<b>1042674</b>	Gilded Bronze	<b>1042676</b>	Satin Nickel
<b>1042673</b>	Brushed Bronze	<b>1042678</b>	Gunmetal		

Finial plugs included.  
Brackets sold separately.

## 8' Fixed Width Pole



Diameter	Length	Quantity per Box
1"	8'	9 pieces per box

### Product Number & Finish

<b>1042679</b>	Antique Silver	<b>1042686</b>	Elegant Brass	<b>1042684</b>	Polished Nickel
<b>1042680</b>	Black	<b>1042682</b>	Gilded Bronze	<b>1042685</b>	Satin Nickel
<b>1042681</b>	Brushed Bronze	<b>1042687</b>	Gunmetal		

Finial plugs included.  
Brackets sold separately.

## Internal Rod Splice



Fits	Quantity per Box
1" Designer Metals™ Poles	6 pieces per box

### Product Number & Finish

<b>1042812</b>	Bright Zinc
----------------	-------------

Connects two poles together for larger width options.

# 1" Rings

## Ring



Fits	Dimensions	Quantity per Box
1" Designer Metals™ Poles	Internal: 1 $\frac{3}{8}$ " External: 1 $\frac{11}{16}$ " External to eyelet: 2"	4 boxes per carton - 7 rings in each box

Product Number & Finish					
1042771	Antique Silver	1042777	Elegant Brass	1042775	Polished Nickel
1042772	Black	1042774	Gilded Bronze	1042776	Satin Nickel
1042773	Brushed Bronze	1042778	Gunmetal		

## Bypass C-Ring



Fits	Dimensions	Quantity per Box
1" Designer Metals™ Poles	Internal: 1 $\frac{3}{8}$ " External: 1 $\frac{11}{16}$ " External to eyelet: 2"	4 boxes per carton - 7 rings in each box

Product Number & Finish					
1042779	Antique Silver	1042785	Elegant Brass	1042783	Polished Nickel
1042780	Black	1042782	Gilded Bronze	1042784	Satin Nickel
1042781	Brushed Bronze	1042786	Gunmetal		

## Ring Lock



Fits	Dimensions	Quantity per Box
1" Designer Metals™ Poles with French Returns	Internal: 1 $\frac{1}{16}$ " External: 1 $\frac{7}{8}$ " External to eyelet: 2 $\frac{3}{16}$ "	8 bags per carton - 1 ring in each bag

Product Number & Finish					
1042763	Antique Silver	1042769	Elegant Brass	1042767	Polished Nickel
1042764	Black	1042766	Gilded Bronze	1042768	Satin Nickel
1042765	Brushed Bronze	1042770	Gunmetal		

## Clips



Fits	Quantity per Box
Designer Metals™ Rings	7 bags per carton - 7 clips in each bag

Product Number & Finish					
1044010	Antique Silver	1044013	Elegant Brass	1044017	Polished Nickel
1044016	Black	1044012	Gilded Bronze	1044011	Satin Nickel
1044015	Brushed Bronze	1044014	Gunmetal		

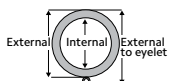

Use the measurement guide to the left to help determine the correct dimensions for your selected product.

# 1" Brackets

## 3" Return O Bracket



Weight limit per bracket for 3" returns is 25 lbs.

Fits	Dimensions	Quantity per Box
1" Designer Metals™ Poles	Depth: 3 <sup>11</sup> / <sub>16</sub> " Height: 2 <sup>3</sup> / <sub>16</sub> " Width: 2 <sup>3</sup> / <sub>16</sub> " Wall to Pole: 2 <sup>3</sup> / <sub>8</sub> " Return: 3"	10 pieces per box

Product Number & Finish					
<b>1042918</b>	Antique Silver	<b>1042924</b>	Elegant Brass	<b>1042922</b>	Polished Nickel
<b>1042919</b>	Black	<b>1042921</b>	Gilded Bronze	<b>1042923</b>	Satin Nickel
<b>1042920</b>	Brushed Bronze	<b>1042925</b>	Gunmetal		

## 6" Return O Bracket



Weight limit per bracket for 6" returns is 12 lbs.

Fits	Dimensions	Quantity per Box
1" Designer Metals™ Poles	Depth: 6 <sup>11</sup> / <sub>16</sub> " Height: 2 <sup>3</sup> / <sub>16</sub> " Width: 2 <sup>3</sup> / <sub>16</sub> " Wall to Pole: 5 <sup>3</sup> / <sub>8</sub> " Return: 6"	10 pieces per box

Product Number & Finish					
<b>1042926</b>	Antique Silver	<b>1042932</b>	Elegant Brass	<b>1042930</b>	Polished Nickel
<b>1042927</b>	Black	<b>1042929</b>	Gilded Bronze	<b>1042931</b>	Satin Nickel
<b>1042928</b>	Brushed Bronze	<b>1042933</b>	Gunmetal		

## 3" Return Bypass O Bracket



Weight limit per bracket for 3" returns is 25 lbs.

Fits	Dimensions	Quantity per Box
1" Designer Metals™ Poles	Depth: 3 <sup>1</sup> / <sub>2</sub> " Height: 2 <sup>3</sup> / <sub>16</sub> " Width: 2 <sup>3</sup> / <sub>16</sub> " Wall to Pole: 2 <sup>3</sup> / <sub>8</sub> " Return: 3"	10 pieces per box

Product Number & Finish					
<b>1042934</b>	Antique Silver	<b>1042940</b>	Elegant Brass	<b>1042938</b>	Polished Nickel
<b>1042935</b>	Black	<b>1042937</b>	Gilded Bronze	<b>1042939</b>	Satin Nickel
<b>1042936</b>	Brushed Bronze	<b>1042941</b>	Gunmetal		

## 6" Return Bypass O Bracket



Weight limit per bracket for 6" returns is 12 lbs.

Fits	Dimensions	Quantity per Box
1" Designer Metals™ Poles	Depth: 6 <sup>1</sup> / <sub>2</sub> " Height: 2 <sup>3</sup> / <sub>16</sub> " Width: 2 <sup>3</sup> / <sub>16</sub> " Wall to Pole: 5 <sup>3</sup> / <sub>8</sub> " Return: 6"	10 pieces per box

Product Number & Finish					
<b>1042942</b>	Antique Silver	<b>1042948</b>	Elegant Brass	<b>1042946</b>	Polished Nickel
<b>1042943</b>	Black	<b>1042945</b>	Gilded Bronze	<b>1042947</b>	Satin Nickel
<b>1042944</b>	Brushed Bronze	<b>1042949</b>	Gunmetal		

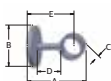

Use the measurement guide to the left to help determine the correct dimensions for your selected product.





1" Gavin | Polished Nickel  
Satin Nickel  
Gunmetal  
Black  
Antique Silver  
Elegant Brass  
Brushed Bronze  
Gilded Bronze

# 1" French Returns

## 3" French Return - Left



Fits		Dimensions		Quantity per Box	
1" Designer Metals™ Poles		Arm Width: 3¼" Overall Width: 4¾" Back Plate Width: 2½" Return: 3"		4 pieces per box	
Product Number & Finish					
1042854	Antique Silver	1042860	Elegant Brass	1042858	Polished Nickel
1042855	Black	1042857	Gilded Bronze	1042859	Satin Nickel
1042856	Brushed Bronze	1042861	Gunmetal		

## 3" French Return - Right



Fits		Dimensions		Quantity per Box	
1" Designer Metals™ Poles		Arm Width: 3¼" Overall Width: 4¾" Back Plate Width: 2½" Return: 3"		4 pieces per box	
Product Number & Finish					
1042862	Antique Silver	1042868	Elegant Brass	1042866	Polished Nickel
1042863	Black	1042865	Gilded Bronze	1042867	Satin Nickel
1042864	Brushed Bronze	1042869	Gunmetal		

## 6" French Return - Left



Fits		Dimensions		Quantity per Box	
1" Designer Metals™ Poles		Arm Width: 3¼" Overall Width: 4¾" Back Plate Width: 2½" Return: 6"		4 pieces per box	
Product Number & Finish					
1042870	Antique Silver	1042876	Elegant Brass	1042874	Polished Nickel
1042871	Black	1042873	Gilded Bronze	1042875	Satin Nickel
1042872	Brushed Bronze	1042877	Gunmetal		

## 6" French Return - Right



Fits		Dimensions		Quantity per Box	
1" Designer Metals™ Poles		Arm Width: 3¼" Overall Width: 4¾" Back Plate Width: 2½" Return: 6"		4 pieces per box	
Product Number & Finish					
1042878	Antique Silver	1042884	Elegant Brass	1042882	Polished Nickel
1042879	Black	1042881	Gilded Bronze	1042883	Satin Nickel
1042880	Brushed Bronze	1042885	Gunmetal		

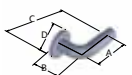



# 1 3/8" Finials

## Archer



Fits	Dimensions	Quantity per Box
1 3/8" Designer Metals™ Poles	Depth: 4"	4 pairs per box
1 3/8" Estate™ Traverse Rods	Height: 3 3/16"	
1 3/8" K-Rail Traverse Rods	Width: 3 3/16"	

Product Number & Finish					
<b>1042982</b>	Antique Silver	<b>1042989</b>	Elegant Brass	<b>1042986</b>	Polished Nickel
<b>1042983</b>	Black	<b>1042985</b>	Gilded Bronze	<b>1042988</b>	Satin Nickel
<b>1042984</b>	Brushed Bronze	<b>1042990</b>	Gunmetal		

## Briggs



Fits	Dimensions	Quantity per Box
1 3/8" Designer Metals™ Poles	Depth: 3 7/16"	4 pairs per box
1 3/8" Estate™ Traverse Rods	Height: 2 3/4"	
1 3/8" K-Rail Traverse Rods	Width: 2 3/4"	

Product Number & Finish					
<b>1042958</b>	Antique Silver	<b>1042964</b>	Elegant Brass	<b>1042962</b>	Polished Nickel
<b>1042959</b>	Black	<b>1042961</b>	Gilded Bronze	<b>1042963</b>	Satin Nickel
<b>1042960</b>	Brushed Bronze	<b>1042965</b>	Gunmetal		

## Briggs - Duotone



Fits	Dimensions	Quantity per Box
1 3/8" Designer Metals™ Poles	Depth: 3 7/16"	4 pairs per box
1 3/8" Estate™ Traverse Rods	Height: 2 3/4"	
1 3/8" K-Rail Traverse Rods	Width: 2 3/4"	

Product Number & Finish	
<b>1043041</b>	Black + Brushed Bronze
<b>1043042</b>	Black + Satin Nickel

## Corsa



Fits	Dimensions	Quantity per Box
1 3/8" Designer Metals™ Poles	Depth: 1 5/8"	4 pairs per box
1 3/8" Estate™ Traverse Rods	Height: 2 1/2"	
1 3/8" K-Rail Traverse Rods	Width: 2 1/2"	

Product Number & Finish					
<b>1831904</b>	Antique Silver	<b>1043899</b>	Elegant Brass	<b>1831957</b>	Polished Nickel
<b>1831921</b>	Black	<b>1831906</b>	Gilded Bronze	<b>1831905</b>	Satin Nickel
<b>1831907</b>	Brushed Bronze	<b>1043943</b>	Gunmetal		

# 1 3/8" Finials

## Elmore

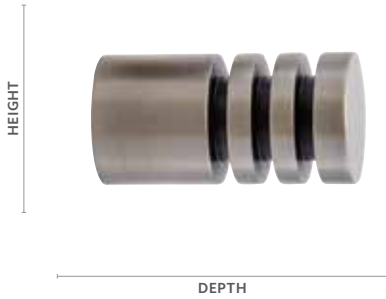

Fits		Dimensions		Quantity per Box	
1 3/8" Designer Metals™ Poles		Depth: 3"		4 pairs per box	
1 3/8" Estate™ Traverse Rods		Height: 1 1/2"			
1 3/8" K-Rail Traverse Rods		Width: 1 1/2"			
Product Number & Finish					
<b>1832170</b>	Antique Silver	<b>1043900</b>	Elegant Brass	<b>1832176</b>	Polished Nickel
<b>1832171</b>	Black	<b>1832174</b>	Gilded Bronze	<b>1832177</b>	Satin Nickel
<b>1832172</b>	Brushed Bronze	<b>1043944</b>	Gunmetal		

## Emerson



Fits		Dimensions		Quantity per Box	
1 3/8" Designer Metals™ Poles		Depth: 2 7/8"		4 pairs per box	
1 3/8" Estate™ Traverse Rods		Height: 2 3/8"			
1 3/8" K-Rail Traverse Rods		Width: 2 3/8"			
Product Number & Finish					
<b>1042974</b>	Antique Silver	<b>1042980</b>	Elegant Brass	<b>1042978</b>	Polished Nickel
<b>1042975</b>	Black	<b>1042977</b>	Gilded Bronze	<b>1042979</b>	Satin Nickel
<b>1042976</b>	Brushed Bronze	<b>1042981</b>	Gunmetal		

## Europa



Fits		Dimensions		Quantity per Box	
1 3/8" Designer Metals™ Poles		Depth: 3"		4 pairs per box	
1 3/8" Estate™ Traverse Rods		Height: 2 3/8"			
1 3/8" K-Rail Traverse Rods		Width: 2 3/8"			
Product Number & Finish					
<b>1831715</b>	Antique Silver	<b>1043901</b>	Elegant Brass	<b>1831963</b>	Polished Nickel
<b>1831717</b>	Black	<b>1831960</b>	Gilded Bronze	<b>1831962</b>	Satin Nickel
<b>1831958</b>	Brushed Bronze	<b>1043945</b>	Gunmetal		

## Harlow



Fits		Dimensions		Quantity per Box	
1 3/8" Designer Metals™ Poles		Depth: 4"		4 pairs per box	
1 3/8" Estate™ Traverse Rods		Height: 1 3/4"			
1 3/8" K-Rail Traverse Rods		Width: 1 3/4"			
Product Number & Finish					
<b>1832146</b>	Antique Silver	<b>1043902</b>	Elegant Brass	<b>1832152</b>	Polished Nickel
<b>1832147</b>	Black	<b>1832150</b>	Gilded Bronze	<b>1832153</b>	Satin Nickel
<b>1832148</b>	Brushed Bronze	<b>1043946</b>	Gunmetal		

# 1 3/8" Finials

## Lennox



Fits		Dimensions		Quantity per Box	
1 3/8" Designer Metals™ Poles		Depth: 1 15/16"		4 pairs per box	
1 3/8" Estate™ Traverse Rods		Height: 3"			
1 3/8" K-Rail Traverse Rods		Width: 3"			
Product Number & Finish					
<b>1042051</b>	Antique Silver	<b>1042058</b>	Elegant Brass	<b>1042055</b>	Polished Nickel
<b>1042052</b>	Black	<b>1042054</b>	Gilded Bronze	<b>1042057</b>	Satin Nickel
<b>1042053</b>	Brushed Bronze	<b>1042059</b>	Gunmetal		

## Odessa



Fits		Dimensions		Quantity per Box	
1 3/8" Designer Metals™ Poles		Depth: 3 7/32"		4 pairs per box	
1 3/8" Estate™ Traverse Rods		Height: 2 7/16"			
1 3/8" K-Rail Traverse Rods		Width: 2 7/16"			
Product Number & Finish					
<b>1042950</b>	Antique Silver	<b>1042956</b>	Elegant Brass	<b>1042954</b>	Polished Nickel
<b>1042951</b>	Black	<b>1042953</b>	Gilded Bronze	<b>1042955</b>	Satin Nickel
<b>1042952</b>	Brushed Bronze	<b>1042957</b>	Gunmetal		

## Pandora



Fits		Dimensions		Quantity per Box	
1 3/8" Designer Metals™ Poles		Depth: 4"		4 pairs per box	
1 3/8" Estate™ Traverse Rods		Height: 2 3/4"			
1 3/8" K-Rail Traverse Rods		Width: 2 3/4"			
Product Number & Finish					
<b>1831705</b>	Antique Silver	<b>1043903</b>	Elegant Brass	<b>1831966</b>	Polished Nickel
<b>1831712</b>	Black	<b>1831707</b>	Gilded Bronze	<b>1831706</b>	Satin Nickel
<b>1831708</b>	Brushed Bronze	<b>1043947</b>	Gunmetal		

## Quinn



Fits		Dimensions		Quantity per Box	
1 3/8" Designer Metals™ Poles		Depth: 3 3/16"		4 pairs per box	
1 3/8" Estate™ Traverse Rods		Height: 2 7/16"			
1 3/8" K-Rail Traverse Rods		Width: 2 7/16"			
Product Number & Finish					
<b>1042966</b>	Antique Silver	<b>1042972</b>	Elegant Brass	<b>1042970</b>	Polished Nickel
<b>1042967</b>	Black	<b>1042969</b>	Gilded Bronze	<b>1042971</b>	Satin Nickel
<b>1042968</b>	Brushed Bronze	<b>1042973</b>	Gunmetal		

# 1 3/8" Finials

## Rao



Fits		Dimensions		Quantity per Box	
1 3/8" Designer Metals™ Poles		Depth: 7/8"		4 pairs per box	
1 3/8" Estate™ Traverse Rods		Height: 1 1/8"			
1 3/8" K-Rail Traverse Rods		Width: 1 1/8"			
Product Number & Finish					
<b>1831883</b>	Antique Silver	<b>1043904</b>	Elegant Brass	<b>1831967</b>	Polished Nickel
<b>1831890</b>	Black	<b>1831885</b>	Gilded Bronze	<b>1831884</b>	Satin Nickel
<b>1831886</b>	Brushed Bronze	<b>1043948</b>	Gunmetal		

## Stratta



Fits		Dimensions		Quantity per Box	
1 3/8" Designer Metals™ Poles		Depth: 2 1/4"		4 pairs per box	
1 3/8" Estate™ Traverse Rods		Height: 2 5/8"			
1 3/8" K-Rail Traverse Rods		Width: 2 5/8"			
Product Number & Finish					
<b>1831634</b>	Antique Silver	<b>1043905</b>	Elegant Brass	<b>1831968</b>	Polished Nickel
<b>1831663</b>	Black	<b>1831598</b>	Gilded Bronze	<b>1831635</b>	Satin Nickel
<b>1831599</b>	Brushed Bronze	<b>1043949</b>	Gunmetal		

## Vivien



Fits		Dimensions		Quantity per Box	
1 3/8" Designer Metals™ Poles		Depth: 3 5/8"		4 pairs per box	
1 3/8" Estate™ Traverse Rods		Height: 2 5/8"			
1 3/8" K-Rail Traverse Rods		Width: 2 5/8"			
Product Number & Finish					
<b>1832186</b>	Antique Silver	<b>1043906</b>	Elegant Brass	<b>1832192</b>	Polished Nickel
<b>1832187</b>	Black	<b>1832190</b>	Gilded Bronze	<b>1832193</b>	Satin Nickel
<b>1832188</b>	Brushed Bronze	<b>1043950</b>	Gunmetal		



1 3/8" Archer | Gunmetal  
Brushed Bronze  
Black

# 1 3/8" Endcaps

## Round Endcap



Fits		Dimensions		Quantity per Box	
1 3/8" Designer Metals™ Poles		Depth: 1 1/8"		4 pairs per box	
1 3/8" Estate™ Traverse Rods		Height: 1 1/2"			
1 3/8" K-Rail Traverse Rods		Width: 1 1/2"			
Product Number & Finish					
<b>1832162</b>	Antique Silver	<b>1043896</b>	Elegant Brass	<b>1832168</b>	Polished Nickel
<b>1832163</b>	Black	<b>1832166</b>	Gilded Bronze	<b>1832169</b>	Satin Nickel
<b>1832164</b>	Brushed Bronze	<b>1043940</b>	Gunmetal		

## Square Endcap



Fits		Dimensions		Quantity per Box	
1 3/8" Designer Metals™ Poles		Depth: 1 3/8"		4 pairs per box	
1 3/8" Estate™ Traverse Rods		Height: 1 5/8"			
1 3/8" K-Rail Traverse Rods		Width: 1 3/8"			
Product Number & Finish					
<b>1832154</b>	Antique Silver	<b>1043897</b>	Elegant Brass	<b>1832160</b>	Polished Nickel
<b>1832155</b>	Black	<b>1832158</b>	Gilded Bronze	<b>1832161</b>	Satin Nickel
<b>1832156</b>	Brushed Bronze	<b>1043941</b>	Gunmetal		

# 1 3/8" Stationary Poles

## 4' Fixed Width Pole



Diameter	Length	Quantity per Box
1 3/8"	4'	4 pieces per box

### Product Number & Finish

<b>1042257</b>	Antique Silver	<b>1042653</b>	Elegant Brass	<b>1042651</b>	Polished Nickel
<b>1042258</b>	Black	<b>1042650</b>	Gilded Bronze	<b>1042652</b>	Satin Nickel
<b>1042259</b>	Brushed Bronze	<b>1042654</b>	Gunmetal		

Finial plugs included.  
Brackets sold separately.

## 6' Fixed Width Pole



Diameter	Length	Quantity per Box
1 3/8"	6'	4 pieces per box

### Product Number & Finish

<b>1042655</b>	Antique Silver	<b>1042661</b>	Elegant Brass	<b>1042659</b>	Polished Nickel
<b>1042656</b>	Black	<b>1042658</b>	Gilded Bronze	<b>1042660</b>	Satin Nickel
<b>1042657</b>	Brushed Bronze	<b>1042662</b>	Gunmetal		

Finial plugs included.  
Brackets sold separately.

## 8' Fixed Width Pole



Diameter	Length	Quantity per Box
1 3/8"	8'	4 pieces per box

### Product Number & Finish

<b>1832019</b>	Antique Silver	<b>1043911</b>	Elegant Brass	<b>1832023PN</b>	Polished Nickel
<b>1832026</b>	Black	<b>1832021</b>	Gilded Bronze	<b>1832020</b>	Satin Nickel
<b>1832022</b>	Brushed Bronze	<b>1043955</b>	Gunmetal		

Finial plugs included.  
Brackets sold separately.

# 1 3/8" Telescoping Poles

## 36"-66" Telescoping Pole



Finial plugs included.  
3 standard brackets included.

Diameter		Length		Quantity per Box	
1 3/8"		36"-66"		4 pieces per box	
Product Number & Finish					
<b>1831267</b>	Antique Silver	<b>1043909</b>	Elegant Brass	<b>1831977</b>	Polished Nickel
<b>1831456</b>	Black	<b>1831451</b>	Gilded Bronze	<b>1831269</b>	Satin Nickel
<b>1831452</b>	Brushed Bronze	<b>1043953</b>	Gunmetal		

## 66"-120" Telescoping Pole



Finial plugs included.  
4 standard brackets included.

Diameter		Length		Quantity per Box	
1 3/8"		66"-120"		4 pieces per box	
Product Number & Finish					
<b>1831458</b>	Antique Silver	<b>1043910</b>	Elegant Brass	<b>1831978</b>	Polished Nickel
<b>1831465</b>	Black	<b>1831460</b>	Gilded Bronze	<b>1831459</b>	Satin Nickel
<b>1831461</b>	Brushed Bronze	<b>1043954</b>	Gunmetal		

## 120"-180" Telescoping Pole



Finial plugs included.  
6 standard brackets included.

Diameter		Length		Quantity per Box	
1 3/8"		120"-180"		2 pieces per box	
Product Number & Finish					
<b>1831467</b>	Antique Silver	<b>1043908</b>	Elegant Brass	<b>1831979</b>	Polished Nickel
<b>1831631</b>	Black	<b>1831469</b>	Gilded Bronze	<b>1831468</b>	Satin Nickel
<b>1831470</b>	Brushed Bronze	<b>1043952</b>	Gunmetal		



# 1 3/8" Estate™ Traverse Rod

To learn more about the technical specs on Estate Traverse Rods and AMP™ Motorization, see pages 44-47.

## Assembled Set with Slides



### Manual Traversing Rods with Selected Carriers

#### Unit of Measure

Foot- Orders over 8 feet will be spliced. A Keystone will be provided to cover the splice.

#### AMP™ Motorization Upcharge

Charger, item #62201300 included. Remotes sold separately.

#### Product Number & Finish

<b>83687867</b>	Antique Silver	<b>83687925</b>	Elegant Brass	<b>83687924</b>	Polished Nickel
<b>83687922</b>	Black	<b>83687920</b>	Gilded Bronze	<b>83687923</b>	Satin Nickel
<b>83687919</b>	Brushed Bronze	<b>83687926</b>	Gunmetal		

## Assembled Set with Wheeled Ripplefold™ Carriers



### Manual Traversing Rods with Selected Carriers

#### Unit of Measure

Foot- Orders over 8 feet will be spliced. A Keystone will be provided to cover the splice.

#### AMP™ Motorization Upcharge

Charger, item #62201300 included. Remotes sold separately.

#### Product Number & Finish

<b>83688867</b>	Antique Silver	<b>83688925</b>	Elegant Brass	<b>83688924</b>	Polished Nickel
<b>83688922</b>	Black	<b>83688920</b>	Gilded Bronze	<b>83688923</b>	Satin Nickel
<b>83688919</b>	Brushed Bronze	<b>83688926</b>	Gunmetal		

## 1 3/8" Estate™ Keystone



#### Fits

#### Quantity per Box

1 3/8" Estate™ Traverse Rods      25 pieces per box

#### Product Number & Finish

<b>1832226</b>	Antique Silver	<b>1043926</b>	Elegant Brass	<b>1832232</b>	Polished Nickel
<b>1832227</b>	Black	<b>1832230</b>	Gilded Bronze	<b>1832233</b>	Satin Nickel
<b>1832228</b>	Brushed Bronze	<b>1043969</b>	Gunmetal		

## Double Bracket

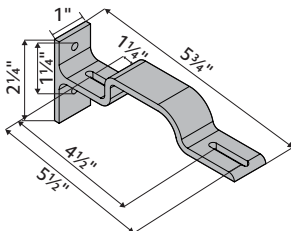

#### Fits

#### Dimensions

#### Quantity per Box

1 3/8" Estate™ Traverse Rods      Depth: 5 3/4"  
 2" Estate™ Traverse Rods      Height: 2 1/4"  
    Width: 1"

#### Product Number & Finish

**71134110**      Satin Brass







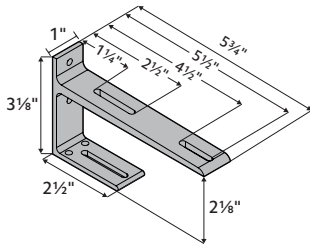

# 1 3/8" Estate™ Traverse Rod Components

To learn more about the technical specs on Estate Traverse Rods and AMP™ Motorization, see pages 44-47.

## Double Bracket



Fits		Dimensions		Quantity per Box
1 3/8" Estate™ Traverse Rods		Depth: 5 3/4"		10 pieces per box
2" Estate™ Traverse Rods		Height: 3 1/8"		
		Width: 1"		
Product Number & Finish				
<b>71132062</b>	Antique Brass	<b>71132110</b>	Satin Brass	
<b>71132006</b>	Black	<b>71132012</b>	Satin Nickel	

Item	Product No. & Finish	Description	Quantity Per Box
	<b>62101000</b> White <b>62101010</b> Black	AMP Remote Control RF 2W 15 Channel	1 piece per box
	<b>62201300</b> White	AMP Battery Charger 16.5V/0.89A	1 piece per box
	<b>62102000</b> White	AMP Gateway USB Bridge	1 piece per box
	<b>62109000</b> White	AMP Wall Switch Surface RF 2W 15 Channel	1 piece per box
	<b>62108000</b> White	AMP Wall Switch RF 2W 15 Channel	1 piece per box
	<b>1026660</b>	15" Cable Assembly	10 pieces per box
	<b>1026661</b>	4' Cable Assembly	10 pieces per box
	<b>1026662</b>	10' Cable Assembly	10 pieces per box
	<b>1026663</b>	20' Cable Assembly	10 pieces per box

# 1 3/8" Rings

## Ring



Clips sold separately.

Fits	Dimensions	Quantity per Box
1 3/8" Designer Metals™ Poles	Internal: 1 3/4" External: 2 1/8" External to eyelet: 2 3/8"	4 boxes per carton - 7 rings in each box

Product Number & Finish					
1043994	Antique Silver	1043997	Elegant Brass	1044001	Polished Nickel
1044000	Black	1043996	Gilded Bronze	1043995	Satin Nickel
1043999	Brushed Bronze	1043998	Gunmetal		

## Bypass C-Ring



Clips sold separately.

Fits	Dimensions	Quantity per Box
1 3/8" Designer Metals™ Poles	Internal: 1 3/4" External: 2 1/8" External to eyelet: 2 3/8"	4 boxes per carton - 7 rings in each box

Product Number & Finish					
1044002	Antique Silver	1044005	Elegant Brass	1044009	Polished Nickel
1044008	Black	1044004	Gilded Bronze	1044003	Satin Nickel
1044007	Brushed Bronze	1044006	Gunmetal		

## Transitional Ring



Clips sold separately.

Fits	Dimensions	Quantity per Box
1 3/8" Designer Metals™ Poles	Internal: 1 5/8" External: 2" External to eyelet: 2 1/2"	4 boxes per carton - 7 rings in each box

Product Number & Finish					
1831549	Antique Silver	1043913	Elegant Brass	1831543PN	Polished Nickel
1831542	Black	1831547	Gilded Bronze	1831548	Satin Nickel
1831546	Brushed Bronze	1043957	Gunmetal		

## Clips



Fits	Quantity per Box
Designer Metals™ Rings	7 bags per carton - 7 clips in each bag

Product Number & Finish					
1044010	Antique Silver	1044013	Elegant Brass	1044017	Polished Nickel
1044016	Black	1044012	Gilded Bronze	1044011	Satin Nickel
1044015	Brushed Bronze	1044014	Gunmetal		

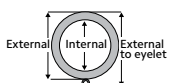

Use the measurement guide to the left to help determine the correct dimensions for your selected product.

# 1 3/8" Rings

## Lock Ring



Fits	Dimensions	Quantity per Box
1 3/8" Designer Metals™ Poles with French Returns	Internal: 1 7/16" External: 2 1/8" External to eyelet: 2 5/8"	8 bags per carton - 1 ring in each bag

### Product Number & Finish

<b>1042605</b>	Antique Silver	<b>1042761</b>	Elegant Brass	<b>1042609</b>	Polished Nickel
<b>1042606</b>	Black	<b>1042608</b>	Gilded Bronze	<b>1042760</b>	Satin Nickel
<b>1042607</b>	Brushed Bronze	<b>1042762</b>	Gunmetal		

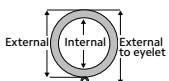

Use the measurement guide to the left to help determine the correct dimensions for your selected product.

# 1 3/8" Brackets

## 3" Return O Bracket



Weight limit per bracket for 3" returns is 32 lbs.

Fits		Dimensions		Quantity per Box	
1 3/8" Designer Metals™ Poles		Depth: 3 7/10"	Height: 3"	10 pieces per box	
		Width: 3/5"	Wall to Pole: 1 3/4"		
		Return: 3"			
Product Number & Finish					
1042706	Antique Silver	1042892	Elegant Brass	1042890	Polished Nickel
1042707	Black	1042709	Gilded Bronze	1042891	Satin Nickel
1042708	Brushed Bronze	1042893	Gunmetal		

## 6" Return O Bracket



Weight limit per bracket for 6" returns is 16 lbs.

Fits		Dimensions		Quantity per Box	
1 3/8" Designer Metals™ Poles		Depth: 6 7/10"	Height: 3"	10 pieces per box	
		Width: 3/5"	Wall to Pole: 4 3/4"		
		Return: 6"			
Product Number & Finish					
1042894	Antique Silver	1042900	Elegant Brass	1042898	Polished Nickel
1042895	Black	1042897	Gilded Bronze	1042899	Satin Nickel
1042896	Brushed Bronze	1042901	Gunmetal		

## 3" Return Bypass O Bracket



Weight limit per bracket for 3" returns is 32 lbs.

Fits		Dimensions		Quantity per Box	
1 3/8" Designer Metals™ Poles		Depth: 3 7/10"	Height: 3"	10 pieces per box	
		Width: 3/5"	Wall to Pole: 1 3/4"		
		Return: 3"			
Product Number & Finish					
1042902	Antique Silver	1042908	Elegant Brass	1042906	Polished Nickel
1042903	Black	1042905	Gilded Bronze	1042907	Satin Nickel
1042904	Brushed Bronze	1042909	Gunmetal		

## 6" Return Bypass O Bracket



Weight limit per bracket for 6" returns is 16 lbs.

Fits		Dimensions		Quantity per Box	
1 3/8" Designer Metals™ Poles		Depth: 6 7/10"	Height: 3"	10 pieces per box	
		Width: 3/5"	Wall to Pole: 4 3/4"		
		Return: 6"			
Product Number & Finish					
1042910	Antique Silver	1042916	Elegant Brass	1042914	Polished Nickel
1042911	Black	1042913	Gilded Bronze	1042915	Satin Nickel
1042912	Brushed Bronze	1042917	Gunmetal		

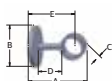

Use the measurement guide to the left to help determine the correct dimensions for your selected product.

# 1 3/8" French Returns

## 3" French Return - Left



Fits		Dimensions		Quantity per Box	
1 3/8" Designer Metals™ Poles		Arm Width: 3 1/4" Overall Width: 4 3/4" Back Plate Width: 3" Return: 3"		4 pieces per box	
Product Number & Finish					
1042592	Antique Silver	1042598	Elegant Brass	1042596	Polished Nickel
1042593	Black	1042595	Gilded Bronze	1042597	Satin Nickel
1042594	Brushed Bronze	1042599	Gunmetal		

## 3" French Return - Right



Fits		Dimensions		Quantity per Box	
1 3/8" Designer Metals™ Poles		Arm Width: 3 1/4" Overall Width: 4 3/4" Back Plate Width: 3" Return: 3"		4 pieces per box	
Product Number & Finish					
1042830	Antique Silver	1042836	Elegant Brass	1042834	Polished Nickel
1042831	Black	1042833	Gilded Bronze	1042835	Satin Nickel
1042832	Brushed Bronze	1042837	Gunmetal		

## 6" French Return - Left



Fits		Dimensions		Quantity per Box	
1 3/8" Designer Metals™ Poles		Arm Width: 3 1/4" Overall Width: 4 3/4" Back Plate Width: 3" Return: 6"		4 pieces per box	
Product Number & Finish					
1042838	Antique Silver	1042844	Elegant Brass	1042842	Polished Nickel
1042839	Black	1042841	Gilded Bronze	1042843	Satin Nickel
1042840	Brushed Bronze	1042845	Gunmetal		

## 6" French Return - Right



Fits		Dimensions		Quantity per Box	
1 3/8" Designer Metals™ Poles		Arm Width: 3 1/4" Overall Width: 4 3/4" Back Plate Width: 3" Return: 6"		4 pieces per box	
Product Number & Finish					
1042846	Antique Silver	1042852	Elegant Brass	1042850	Polished Nickel
1042847	Black	1042849	Gilded Bronze	1042851	Satin Nickel
1042848	Brushed Bronze	1042853	Gunmetal		

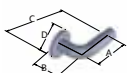



1 3/8" French Return + Lock Ring | Black

# 1 3/8" Decorative Brackets

## Decorative Bracket



Fits		Dimensions		Quantity per Box	
1 3/8" Designer Metals™ Poles		Depth: 4 1/8"-5 1/8"	Height: 3"	10 pieces per box	
		Width: 7/8"	Wall to Pole: 2 1/8"-3 1/8"		
		Return: 3"-4"			
Product Number & Finish					
<b>1832074</b>	Antique Silver	<b>1043895</b>	Elegant Brass	<b>1832080</b>	Polished Nickel
<b>1832075</b>	Black	<b>1832078</b>	Gilded Bronze	<b>1832081</b>	Satin Nickel
<b>1832076</b>	Brushed Bronze	<b>1043939</b>	Gunmetal		

## Decorative Bypass Bracket



Fits		Dimensions		Quantity per Box	
1 3/8" Designer Metals™ Poles		Depth: 3 3/4"-4 3/4"	Height: 3"	10 pieces per box	
		Width: 7/8"	Wall to Pole: 2 1/8"-3 1/8"		
		Return: 3"-4"			
Product Number & Finish					
<b>1832090</b>	Antique Silver	<b>1043887</b>	Elegant Brass	<b>1832096</b>	Polished Nickel
<b>1832091</b>	Black	<b>1832094</b>	Gilded Bronze	<b>1832097</b>	Satin Nickel
<b>1832092</b>	Brushed Bronze	<b>1043931</b>	Gunmetal		

## Decorative Ceiling Bracket



Fits		Dimensions		Quantity per Box	
1 3/8" Designer Metals™ Poles		Depth: 3"	Height: 3 3/4"-4 3/4"	10 pieces per box	
		Width: 7/8"	Ceiling to Pole: 2 5/8"-3 5/8"		
		Back Edge to Pole: 2 7/8"			
Product Number & Finish					
<b>1832082</b>	Antique Silver	<b>1043889</b>	Elegant Brass	<b>1832088</b>	Polished Nickel
<b>1832083</b>	Black	<b>1832086</b>	Gilded Bronze	<b>1832089</b>	Satin Nickel
<b>1832084</b>	Brushed Bronze	<b>1043933</b>	Gunmetal		

## Decorative Ceiling Bypass Bracket



Fits		Dimensions		Quantity per Box	
1 3/8" Designer Metals™ Poles		Depth: 3"	Height: 3 5/8"-4 5/8"	10 pieces per box	
		Width: 7/8"	Ceiling to Pole: 2 5/8"-3 5/8"		
		Back Edge to Pole: 3"			
Product Number & Finish					
<b>1832098</b>	Antique Silver	<b>1043890</b>	Elegant Brass	<b>1832104</b>	Polished Nickel
<b>1832099</b>	Black	<b>1832102</b>	Gilded Bronze	<b>1832105</b>	Satin Nickel
<b>1832100</b>	Brushed Bronze	<b>1043934</b>	Gunmetal		





# 1 3/8" Decorative Brackets

## Decorative Double Bracket



Fits		Dimensions		Quantity per Box	
1 3/8" Designer Metals™ Poles		Depth: 7 1/8"-8 1/8"	Height: 3"	10 pieces per box	
		Width: 7/8"	Wall to Back Pole: 2 1/8"-3 1/8"		
		Inner Return: 3"-4"	Outer Return: 6"-7"		
Product Number & Finish					
1832106	Antique Silver	1043893	Elegant Brass	1832112	Polished Nickel
1832107	Black	1832110	Gilded Bronze	1832113	Satin Nickel
1832108	Brushed Bronze	1043937	Gunmetal		

## Decorative Double Bypass Bracket



Fits		Dimensions		Quantity per Box	
1 3/8" Designer Metals™ Poles		Depth: 7"-8"	Height: 3"	10 pieces per box	
		Width: 7/8"	Wall to Back Pole: 2 1/4"-3 1/4"		
		Inner Return: 3 1/4"-4 1/4"	Outer Return: 6 1/4"-7 1/4"		
Product Number & Finish					
1832122	Antique Silver	1043894	Elegant Brass	1832128	Polished Nickel
1832123	Black	1832126	Gilded Bronze	1832129	Satin Nickel
1832124	Brushed Bronze	1043938	Gunmetal		

## Decorative Ceiling Double Bracket



Fits		Dimensions		Quantity per Box	
1 3/8" Designer Metals™ Poles		Depth: 5 1/8"	Height: 3 5/8"-4 5/8"	10 pieces per box	
		Width: 7/8"	Ceiling to Pole: 2 5/8"-3 3/8"		
			Back Edge to Pole: 3 1/2"		
Product Number & Finish					
1832114	Antique Silver	1043891	Elegant Brass	1832120	Polished Nickel
1832115	Black	1832118	Gilded Bronze	1832121	Satin Nickel
1832116	Brushed Bronze	1043935	Gunmetal		

## Decorative Bracket Extension



Fits		Dimensions		Quantity per Box	
1 3/8" Designer Metals™ Poles		Depth: 3"-4"	Height: 1/2"	10 pieces per box	
		Width: 1/2"			
Product Number & Finish					
1832138	Antique Silver	1043886	Elegant Brass	1832144	Polished Nickel
1832139	Black	1832142	Gilded Bronze	1832145	Satin Nickel
1832140	Brushed Bronze	1043930	Gunmetal		

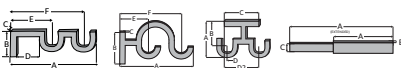

Use the measurement guide to the left to help determine the correct dimensions for your selected product.

# 1 3/8" Standard Brackets

## Standard Bracket



Fits		Dimensions		Quantity per Box	
1 3/8" Designer Metals™ Poles		Depth: 5 1/4"-7" Height: 2 3/8" Width: 1" Wall to Pole: 3 1/2"-5 1/4" Return: 4 3/8"-6 1/8"		10 pieces per box	
Product Number & Finish					
<b>1858569</b>	Antique Silver	<b>1043885</b>	Elegant Brass	*	Polished Nickel
<b>1858572</b>	Black	<b>1858568</b>	Gilded Bronze	<b>1858570</b>	Satin Nickel
<b>1858574</b>	Brushed Bronze	<b>1043929</b>	Gunmetal		

\*Order Satin Nickel for Polished Nickel



# 1 3/8" Accessories & Components

## Inside Mount Socket



Fits	Dimensions	Quantity per Box
1 3/8" Designer Metals™ Poles	Depth: 1 1/4" Height: 1 5/8" Width: 1 5/8"	4 pairs per box

Product Number & Finish					
1832218	Antique Silver	1043907	Elegant Brass	1832224	Polished Nickel
1832219	Black	1832222	Gilded Bronze	1832225	Satin Nickel
1832220	Brushed Bronze	1043951	Gunmetal		

Mounts a 1 3/8" rod between two facing walls.

## Swivel Socket



Fits	Dimensions	Quantity per Box
1 3/8" Designer Metals™ Poles 1 3/8" Estate™ Traverse Rods 1 3/8" K-Rail Traverse Rods	Length to Center: 1 1/2" Pole Diameter: 1 7/16" Full Length: 1 7/8" Depth of Socket: 1/8"	4 pieces per box

Product Number & Finish					
1831428	Antique Silver	1043912	Elegant Brass	1831422PN	Polished Nickel
1831421	Black	1831426	Gilded Bronze	1831427	Satin Nickel
1831425	Brushed Bronze	1043956	Gunmetal		

## 36" Baton with Bypass C-Ring



End of Baton

Fits	Dimensions	Quantity per Box
1 3/8" Designer Metals™ Poles	36" Long	6 pieces per box

Product Number & Finish					
1831558	Antique Silver	1043921	Elegant Brass	1831559	Polished Nickel
1831551	Black	1831556	Gilded Bronze	1831557	Satin Nickel
1831555	Brushed Bronze	1043965	Gunmetal		

## Finial Plug



Fits	Quantity per Box
1 3/8" Designer Metals™ Poles	20 pieces per box

Product Number & Finish	
73405058	White

Can be used with stationary fixed width & telescoping rods.

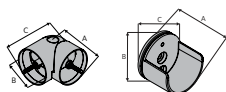

Use the measurement guide to the left to help determine the correct dimensions for your selected product.

# 1 3/8" Components

## Internal Rod Splice

---



Fits	Quantity per Box
1 3/8" Designer Metals™ Poles	6 pieces per box

Product Number & Finish
<b>73304061</b> Bright Zinc

Connects two poles together for larger width options.

## Finial Wall Mount

---



Fits	Quantity per Box
1 3/8" Designer Metals™ Finials	4 pairs per box

Product Number & Finish
<b>54780058</b> White

Use with decorative finial.

## Teflon Tape

---



Quantity per Roll	Quantity per Box
54' per roll	1 roll per box

Product Number & Finish
<b>84990000</b> Clear

Teflon tape is used on stationary poles to help rings slide smoothly across the pole.

# 2" Finials & Endcaps

## Corsa



Fits		Dimensions		Quantity per Box	
2" Estate™ Traverse Rods		Depth: 2¼"	Height: 3½"	4 pairs per box	
		Width: 3½"			
Product Number & Finish					
<b>1832001</b>	Antique Silver	<b>1043915</b>	Elegant Brass	<b>1831952</b>	Polished Nickel
<b>1832008</b>	Black	<b>1832003</b>	Gilded Bronze	<b>1832002</b>	Satin Nickel
<b>1832004</b>	Brushed Bronze	<b>1043959</b>	Gunmetal		

## Europa



Fits		Dimensions		Quantity per Box	
2" Estate™ Traverse Rods		Depth: 4¼"	Height: 3¾"	4 pairs per box	
		Width: 3¾"			
Product Number & Finish					
<b>1832202</b>	Antique Silver	<b>1043916</b>	Elegant Brass	<b>1832208</b>	Polished Nickel
<b>1832203</b>	Black	<b>1832206</b>	Gilded Bronze	<b>1832209</b>	Satin Nickel
<b>1832204</b>	Brushed Bronze	<b>1043960</b>	Gunmetal		

## Pandora



Fits		Dimensions		Quantity per Box	
2" Estate™ Traverse Rods		Depth: 5⅝"	Height: 3¾"	4 pairs per box	
		Width: 3¾"			
Product Number & Finish					
<b>1831981</b>	Antique Silver	<b>1043917</b>	Elegant Brass	<b>1831980</b>	Polished Nickel
<b>1831988</b>	Black	<b>1831983</b>	Gilded Bronze	<b>1831982</b>	Satin Nickel
<b>1831984</b>	Brushed Bronze	<b>1043961</b>	Gunmetal		

## Rao



Fits		Dimensions		Quantity per Box	
2" Estate™ Traverse Rods		Depth: 1⅝"	Height: 2½"	4 pairs per box	
		Width: 2½"			
Product Number & Finish					
<b>1831992</b>	Antique Silver	<b>1043918</b>	Elegant Brass	<b>1930946</b>	Polished Nickel
<b>1831999</b>	Black	<b>1831994</b>	Gilded Bronze	<b>1831993</b>	Satin Nickel
<b>1831995</b>	Brushed Bronze	<b>1043962</b>	Gunmetal		

# 2" Finials & Endcaps

## Stratta



Fits		Dimensions		Quantity per Box	
2" Estate™ Traverse Rods		Depth: 3 1/8"	Height: 3 3/8"	4 pairs per box	
Width: 3 5/8"					
Product Number & Finish					
<b>1832210</b>	Antique Silver	<b>1043919</b>	Elegant Brass	<b>1832216</b>	Polished Nickel
<b>1832211A</b>	Black	<b>1832214</b>	Gilded Bronze	<b>1832217</b>	Satin Nickel
<b>1832212</b>	Brushed Bronze	<b>1043963</b>	Gunmetal		



1 3/8" Briggs | Black + Brushed Bronze  
1" Maxwell



1 3/8" Briggs | Black + Satin Nickel  
1" Maxwell

# 2" Estate™ Traverse Rods

To learn more about the technical specs on Estate Traverse Rods and AMP™ Motorization, see pages 44-47.

## Assembled Set with Slides



### Manual Traversing Rods with Selected Carriers

#### Unit of Measure

Foot - Orders over 8 feet will be spliced. A Keystone will be provided to cover the splice.

#### AMP™ Motorization Upcharge

Charger, item #62201300 included. Remotes sold separately.

#### Product Number & Finish

<b>93685867</b>	Antique Silver	<b>93685925</b>	Elegant Brass	<b>93685924</b>	Polished Nickel
<b>93685922</b>	Black	<b>93685920</b>	Gilded Bronze	<b>93685923</b>	Satin Nickel
<b>93685919</b>	Brushed Bronze	<b>93685926</b>	Gunmetal		

## Assembled Set with Wheeled Ripplefold™ Carriers



### Manual Traversing Rods with Selected Carriers

#### Unit of Measure

Foot - Orders over 8 feet will be spliced. A Keystone will be provided to cover the splice.

#### AMP™ Motorization Upcharge

Charger, item #62201300 included. Remotes sold separately.

#### Product Number & Finish

<b>93686867</b>	Antique Silver	<b>93686925</b>	Elegant Brass	<b>93686924</b>	Polished Nickel
<b>93686922</b>	Black	<b>93686920</b>	Gilded Bronze	<b>93686923</b>	Satin Nickel
<b>93686919</b>	Brushed Bronze	<b>93686926</b>	Gunmetal		



**2" Estate™ Rod With Slides | Black**

Custom sizes only.  
Available in 1½" & 2".



**1½" Estate™ Rod With Slides | Antique Silver**

Custom sizes only.  
Available in 1½" & 2".



**2" Estate™ Rod With Ripplefold™ | Gilded Bronze**

Custom sizes only.  
Available in 1½" & 2".

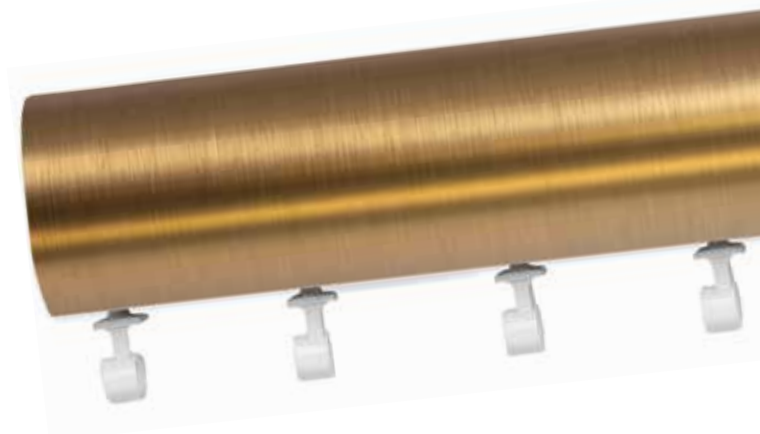

**Estate™ Keystones | Gilded Bronze**

Available in 1½" & 2".









# 2" Estate™ Traverse Rod Components

To learn more about the technical specs on Estate Traverse Rods and AMP™ Motorization, see pages 44-47.

## 2" Estate™ Keystone



Fits		Quantity per Box	
2" Estate™ Traverse Rods		25 pieces per box	
Product Number & Finish			
<b>1832234</b>	Antique Silver	<b>1043927</b>	Elegant Brass
<b>1832235</b>	Black	<b>1832238</b>	Gilded Bronze
<b>1832236</b>	Brushed Bronze	<b>1043970</b>	Gunmetal
<b>1832240</b>	Polished Nickel	<b>1832241</b>	Satin Nickel

Item	Product No. & Finish	Description	Quantity Per Box
	<b>62101000</b> White <b>62101010</b> Black	AMP Remote Control RF 2W 15 Channel	1 piece per box
	<b>62201300</b> White	AMP Battery Charger 16.5V/0.89A	1 piece per box
	<b>62102000</b> White	AMP Gateway USB Bridge	1 piece per box
	<b>62109000</b> White	AMP Wall Switch Surface RF 2W 15 Channel	1 piece per box
	<b>62108000</b> White	AMP Wall Switch RF 2W 15 Channel	1 piece per box
	<b>1026660</b>	15" Cable Assembly	10 pieces per box
	<b>1026661</b>	4' Cable Assembly	10 pieces per box
	<b>1026662</b>	10' Cable Assembly	10 pieces per box
	<b>1026663</b>	20' Cable Assembly	10 pieces per box

# 2" Accessories

## Swivel Socket



Fits	Dimensions	Quantity per Box
2" Estate™ Traverse Rods	Length to Center: 1 3/8" Pole Diameter: 2 1/16" Full Length: 2 1/16" Depth of Socket: 1/4"	4 pieces per box

Product Number & Finish			
<b>1831419</b>	Antique Silver	<b>1043920</b>	Elegant Brass
<b>1831412</b>	Black	<b>1831417</b>	Gilded Bronze
<b>1831416</b>	Brushed Bronze	<b>1043964</b>	Gunmetal
		<b>1831413PN</b>	Polished Nickel
		<b>1831418</b>	Satin Nickel

## Double Bracket

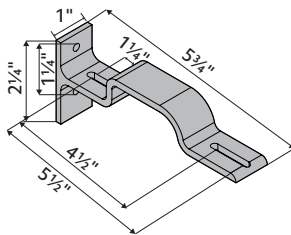

Fits	Dimensions	Quantity per Box
1 3/8" Estate™ Traverse Rods 2" Estate™ Traverse Rods	Depth: 5 3/4" Height: 2 1/4" Width: 1"	10 pieces per box

Product Number & Finish	
<b>71134110</b>	Satin Brass

## Double Bracket

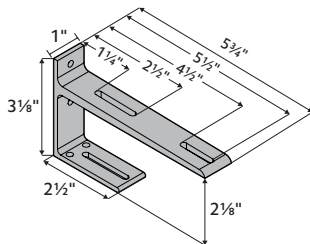

Fits	Dimensions	Quantity per Box
1 3/8" Estate™ Traverse Rods 2" Estate™ Traverse Rods	Depth: 5 3/4" Height: 3 1/8" Width: 1"	10 pieces per box

Product Number & Finish			
<b>71132062</b>	Antique Brass	<b>71132110</b>	Satin Brass
<b>71132006</b>	Black	<b>71132012</b>	Satin Nickel



Use the measurement guide to the left to help determine the correct dimensions for your selected product.

# AMP™ Motorization

## Why AMP™?

The slim design of the quiet, yet powerful motor and the position on the track allows the motor to tuck seamlessly behind your drapery panel so you'll never have to sacrifice your style or comfort. For safety measures, you're able to move the draperies with a gentle tug, allowing for operation when a remote is not present or if a guest is unaware of the motorization feature. The dual battery and AC power sources allows operation in case of a power outage so draperies may be opened in the event of an emergency. AMP™ Motorization is available on our most popular traversing tracks, Estate and Architrac® Series 94001 and in drapery header styles Ripplefold™ and pleated for a variety of styling options. This is comfortable living at its finest.

For AMP™ Motorization brochure, programming instructions and installation instructions, please visit the drapery hardware resource library at [kirsch.com](http://kirsch.com).

## Benefits & Features

### AMP™ Motorization

- Motor mounts to the back of the track which allows a seamless look between motorized and manual traverse rods
- Drapery fabrication does not need to change between manually controlled draperies and motorized draperies; No additional returns or any special instructions
- Limits are set automatically after installation
- Remote control is radio frequency and easily pairs with the motor
- Tug feature; when drapery is pulled the motor will traverse the drapery
- AMP™ App with AMP™ USB Bridge
- Architrac® Series 94001 Rods with AMP™ cannot be bent or curved

## Frequently Asked Questions

### What is the weight capacity?

**64 lbs** Motor is rated to 64 lbs. Be sure not to exceed the Estate or Architrac track specifications to ensure your motor operates optimally.

### Can you double the weight capacity by using two motors?

**No** Only use one motor per rod.

### Does AMP™ offer limit setting?

**Yes** The motor automatically sets its limits.

### Does AMP™ offer touch control?

**Yes** The tug feature allows you to pull on the drapery and the motor will automatically open or close your draperies.

### How long is the power cord?

**6 ft** The durable, non-extendable power cord is extra long for out of reach places. Any extra can be rolled and secured for a tidy look. Cable extensions are available in 15", 4', 10' and 20' lengths to reach outlets that are farther away from the motor.

### Is there a wall switch?

**Yes** There are Flush Mount and Surface Mount Wall Switches available.

### Does AMP™ offer a warranty?

**Yes** See the Kirsch Warranty document for more information.

Download the AMP™ APP to get started



# AMP™ Motorization Overview

## Overview

- Soft start/stop & manual operation
- Tug feature: when drapery is pulled the motor will traverse the drapery
- Automatic limits on end stop
- Favorite/intermediate position
- Dry contact for external control
- RF Remote and wall switches
- Setting with buttons on motor units
- Setting with external dry contact switch
- LED Indicators
- One-Way and Two-Way Draw
- Pleated
- Ripplefold™
- AMP™ App with AMP™ USB Bridge

## Available Colors

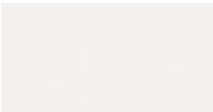

White

## Side View



## Front View

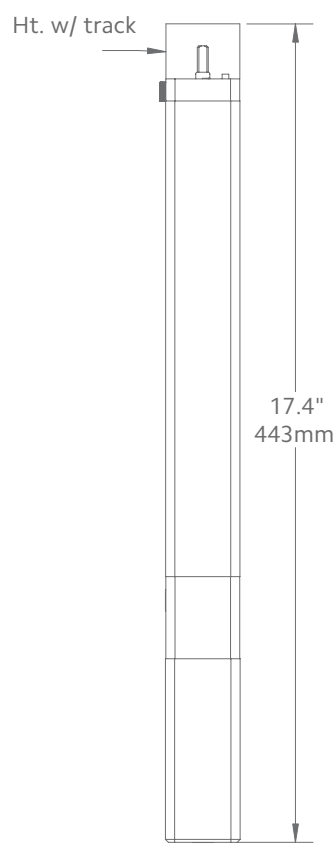

## Bottom View

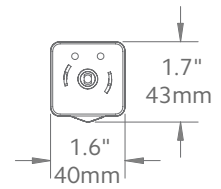

Motor Unit	Product No.
AMP™ Drapery Motor	62001300

Technical Specs	AMP™ Motor
Power Supply	DC 16.5V-0.89A (100-240VAC 50/60Hz 0.5A)
Amperage	2.55Ah
Average Linear Speed	7.8inches/sec
Power Consumption	40 watts
Torque	1.2Nm
Power Cable Length	6 feet
Variable Speed	80, 100 & 120 rpm
Certifications	UL/CE
Max. Track Length	Estate™ - 16 ft Architrac™ 94001 - 16 ft
Max. Load	64 lbs

Follow track specifications for drapery weight.



# Estate™ Overview

To help determine which system is right for your project, use the guideline below to select the best fit. For more detailed information about each track, please visit our resource library at [kirsch.com](http://kirsch.com).

Estate™ Series	Designer Metals™	Wood Trends™	Wrought Iron	Varia	Chroma
<b>What is your preferred size?</b>					
1 3/8"	•	•	•		
2"	•	•		•	•
<b>What is your preferred Draw type?</b>					
Motorized	•	•	•	•	•
Manual	•	•	•	•	•
<b>What is your preferred Drapery Heading type?</b>					
Pleated	•	•	•	•	•
Ripplefold™	•	•	•	•	•
<b>What is your mounting location?</b>					
Ceiling Mount*	•	•	•	•	•
Wall Mount	•	•	•	•	•

\*Finial choices may be limited for ceiling mounted Estate™ Rods.

## Track Performance Data

Style	Heading Style	Mount	Draw	Minimum Track Length	Maximum Track Length	Minimum Fabric Weight	Lbs. per Ft.
 83611 1 3/8" Estate™ Manual or Motorized Draw	Pleated, Ripplefold™	Ceiling, Wall	One-Way	18 in	16 ft	64 lbs	4
			Two-Way	18 in	16 ft	64 lbs	4
 93601 2" Estate™ Manual or Motorized Draw	Pleated, Ripplefold™	Ceiling, Wall	One-Way	18 in	16 ft	64 lbs	4
			Two-Way	18 in	16 ft	64 lbs	4

\*Maximum track lengths and maximum fabric weight do not apply to curved track. Check with customer service for feasibility. Send complete specifications and fabric weight.

## Splices & Keystones per Track

Track Length	Number of Splices	Keystones Included
8 ft. to 16 ft.	1	1

# Operating Systems

---

## Motorized Draw

### AMP™ Motorization

---

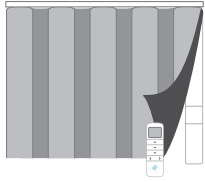

- Easy to use
- Quiet, powerful motor
- Pleated or Ripplefold™
- For Estate™ Traverse Rods or Architrac® Series 94001
- For more information, see page 46

## Manual Draw

### Cord Draw

---

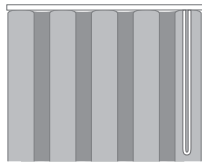

- Easy to use
- Pleated or Ripplefold™

### Hand/Baton Draw

---

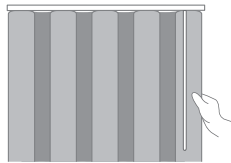

- Easy to use
- A gentle tug allows drapery to glide across track
- Pleated or Ripplefold™

### Baton Duplex Draw

---

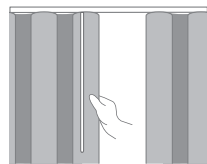

- Easy to use
- Used on split draw rods
- Pleated or Ripplefold™
- When the baton is pulled on one stack, draperies on both sides of the traverse rod open or close

# Header Styles

---

## Ripplefold™

---

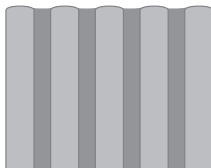

- Panels can be pressed flat, yet fall into fold
- No hooks or pins
- Headings are suspended under track
- Stack back is less than conventional pleated draperies
- Draperies snap on/off carriers for easy installation
- Interior drapery appearance is identical to exterior-facing appearance

## Pleated

---

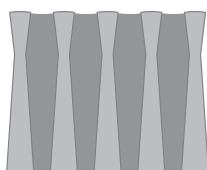

- A classic header option
- Can be used with most track systems using slip-in or pin-on hooks
- Headings can be suspended under the track or over the face of the track to conceal hardware
- Four carriers per foot is standard, additional carriers or rings can be ordered

# Bracket Spacing & Mount Options

Place brackets at each end. On the ends where the drapery will stack, place the next bracket at a maximum of 24" from the first bracket, then place remaining brackets at 48" intervals over the remainder of the track. Spacing may need to be shortened for heavier draperies. All mounting options are compatible with our AMP™ Motorization.



## Wall Mount using parts:

To achieve this look, order Estate rod, wall mount and all components will be included.

94129061  
Zinc

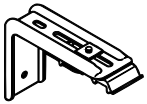

or

1856973  
Satin Nickel

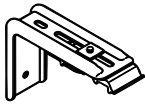

or

1856978  
Brushed Bronze

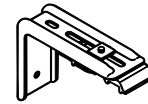

or

1857324  
Black

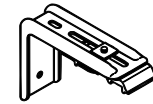

## 1 3/8" Wall Mount

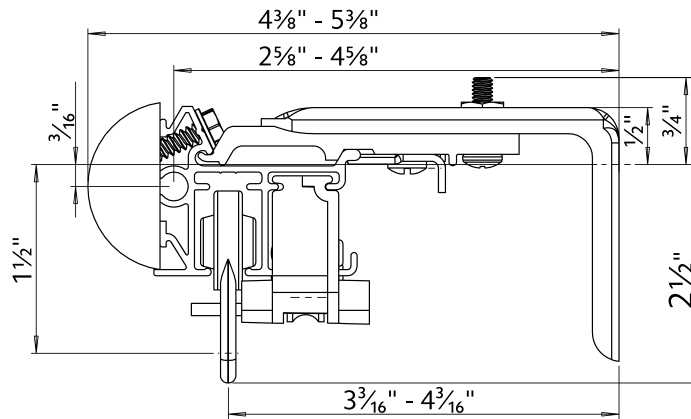

## 2" Wall Mount

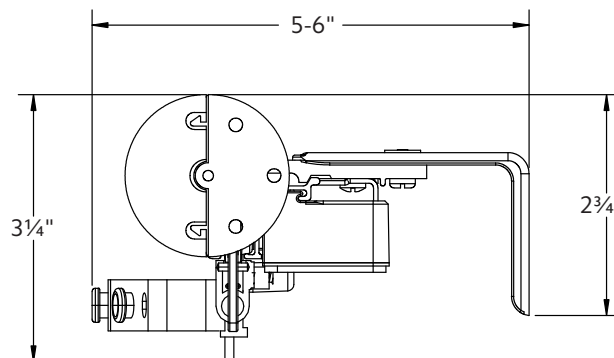



## Ceiling Mount using parts:

To achieve this look, order Estate rod, ceiling mounted. 94130xxx brackets are included with the rod. Then order item 1796061 ceiling mount bracket in the quantity needed based on the bracket spacing drawing on page 40.

94130xxx



8

1796061

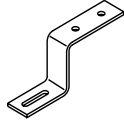

## 1 3/8" Ceiling Mount

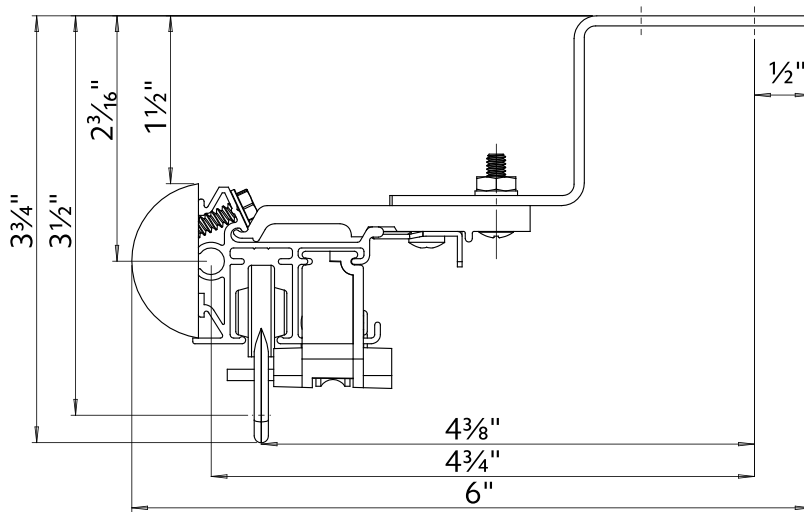

## 2" Ceiling Mount

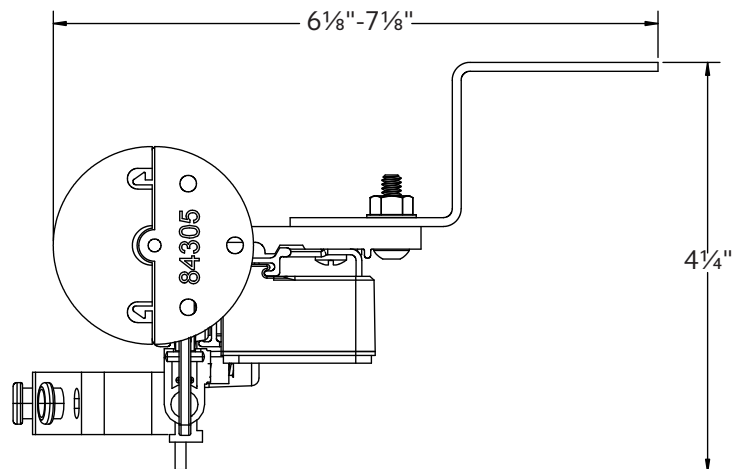

## Double Wall Mount using parts:

To achieve this look, order Estate rod, ceiling mounted. 94130xxx brackets are included with the rod. Then order one, item 94125xxx double bracket and two, item 1796061 ceiling mount brackets multiplied by the quantity needed based on the bracket spacing drawing on page 40.

94125xxx



⊞

1796061

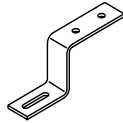

⊞

94130xxx



## 1 3/8" Double Wall Mount

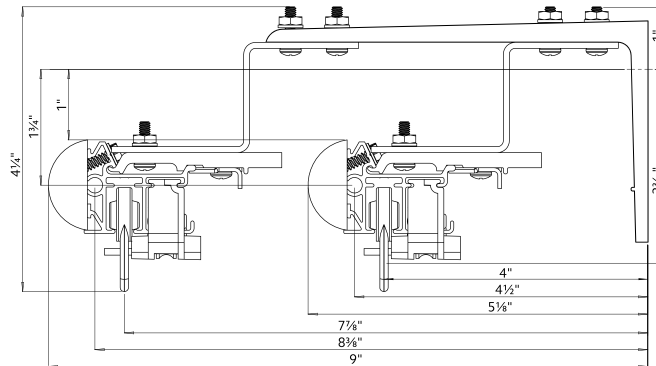

## 2" Double Wall Mount

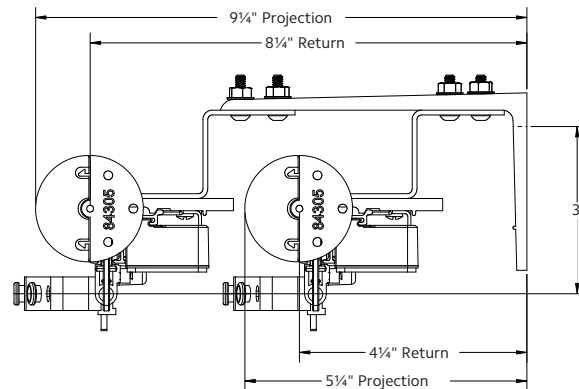

## 2" Front & 1 3/8" Back Double Wall Mount

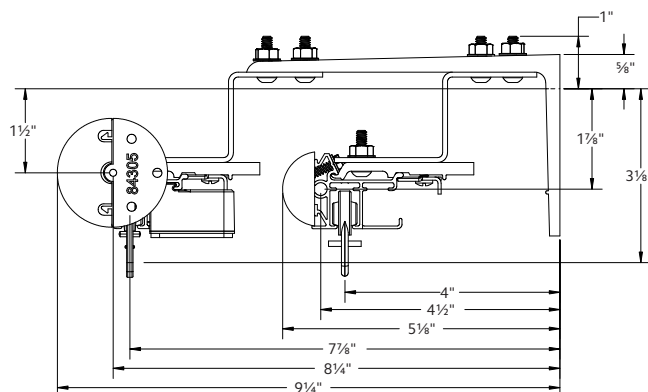

## Double Wall Mount using parts:

To achieve this look, order Estate rod ceiling mounted. 94130xxx brackets are included with the rod. Then order one, item 71134110 double bracket in the quantity needed based on the bracket spacing drawing on page 40.

71134110

&

94130xxx

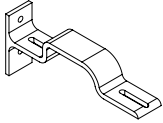

### 2" Front & 1 3/8" Back Double Wall Mount

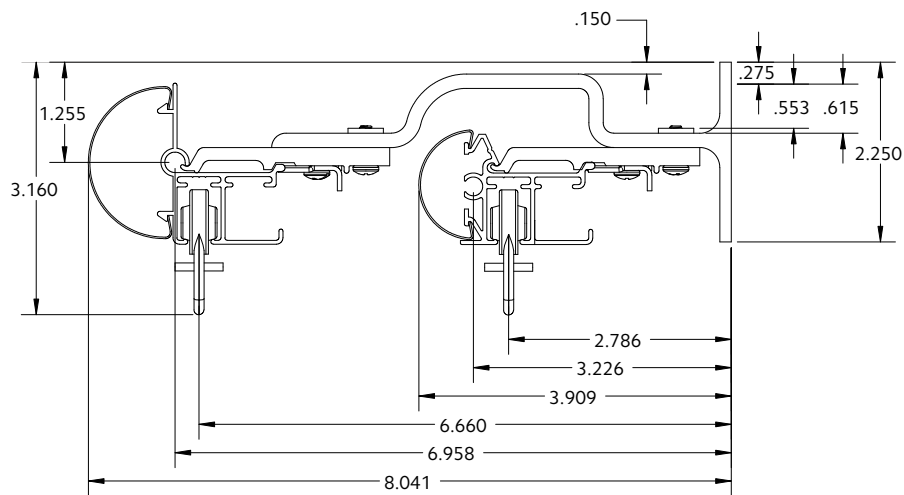

### 1 3/8" Front & 1 3/8" Back Double Wall Mount

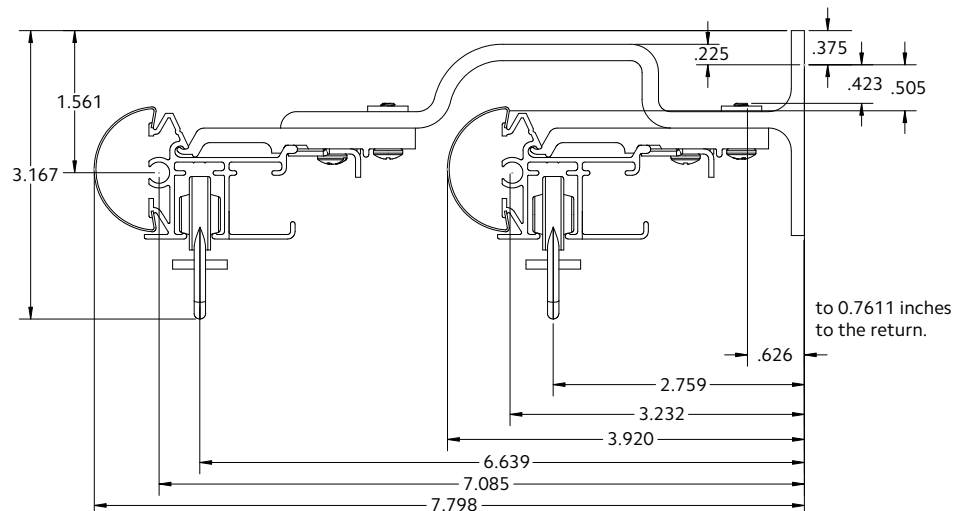

# Calculating Drapery Weight

## 1. Fabric Weight

Some fabric samples list on the back of the swatch the weight listed in Ounces/SqYd (ounces per square yard). Call the manufacturer for the weight if not listed.

## 2. Lining Weight

Most drapery linings are 2oz - 4oz per square yard.

### Drapery Weight Formula

---

**Total Square Yards** = (total yards x 36 x fabric width) ÷ 1296 (1-square yard)

**Weight** = total square yards x weight in ounces per SqYd) ÷ 16 oz in lb

**Example** 32 yards of 54" wide fabric weighing 14 oz/SqYd  
Total square yards = (32 x 36 x 54) = 62,208 ÷ 1296 = 48 SqYds  
Weight = (48 x 14oz) = 672 ÷ 16 = 42 lbs

### Lining Weight Formula

---

**Total Square Yards** = (total yards x 36 x fabric width) ÷ 1296 (1-square yard)

**Weight** = total square yards x weight in ounces per SqYd) ÷ 16 oz in lb

**Example** 32 yards of 54" wide fabric weighing 6 oz/SqYd  
Total square yards = (32 x 36 x 54) = 62,208 ÷ 1296 = 48 SqYds  
Weight = (48 x 4oz) = 192 ÷ 16 = 12 lbs

## Fabrics by Weight

Contact the fabric manufacturer for your specific fabric weight.

---

Fabric Type	Weight per Square Yard
Drapery Lining	2-4oz
Interlining	5-6oz
Blackout Lining	6-10oz
Bump Lining	12-14oz
Silks	2-4oz
Chintz	2-4oz
Printed Cottons	4-6oz
Linens	6-10oz
Jacquards	10-14oz
Velvets	14-18oz

---

# Stack Guides

## Pleated Stack Guide (for 16 mm carriers)

Note: Stack size is estimated. Type of fabric used could alter these measurements.

Size of Track (in inches)	5 carriers per foot 3x fullness		4 carriers per foot 2½x fullness		3 carriers per foot 2x fullness	
	Stackback One-Way	Stackback Two-Way (per side)	Stackback One-Way	Stackback Two-Way (per side)	Stackback One-Way	Stackback Two-Way (per side)
18	11.75	8.75	10.5	8.5	10.5	8.5
24	13	9.25	11.75	8.75	10.5	8.5
30	15.75	10.5	13	9.25	11.75	8.75
36	17	11.25	14.5	10	13	9.25
42	18.5	12	15.75	10.5	14.5	10
48	19.75	12.5	17	11.25	14.5	10
54	22.25	14	18.5	12	15.75	10.5
60	23.75	14.5	19.75	12.5	17	11.25
66	25	15.25	21	13.25	18.5	12
72	26.25	16	22.25	14	18.5	12
78	29	17.25	23.75	14.5	19.75	12.5
84	30.25	18	25	15.25	21	13.25
90	31.5	18.5	26.25	16	22.25	14
96	33	19.25	27.5	16.5	22.25	14
102	35.5	20.5	29	17.25	23.75	14.5
108	36.75	21.25	30.25	18	25	15.25
114	38.25	21.75	31.5	18.5	26.25	16
120	39.5	22.5	33	19.25	26.25	16
126	42.25	23.75	34.25	19.75	27.5	16.5
132	43.5	24.5	35.5	20.5	29	17.25
138	44.75	25.25	36.75	21.25	30.25	18
144	46	25.75	38.25	21.75	30.25	18
150	48.75	27	39.5	22.5	31.5	18.5
156	50	27.75	40.75	23.25	33	19.25
162	51.5	28.5	42.25	23.75	34.25	19.75
168	52.75	29	43.5	24.5	34.25	19.75
174	55.25	30.5	44.75	25.25	35.5	20.5
180	56.75	31	46	25.75	36.75	21.25
186	58	31.75	47.5	26.5	38.25	21.75
192	59.25	32.5	48.75	27	38.25	21.75
198	62	33.75	50	27.75	39.5	22.5
204	63.25	34.5	51.5	28.5	40.75	23.25
210	64.5	35	52.75	29	42.25	23.75
216	66	35.75	54	29.75	42.25	23.75
222	68.5	37	55.25	30.5	43.5	24.5
228	69.75	37.75	56.75	31	44.75	25.25
234	71.25	38.25	58	31.75	46	25.75
240	72.5	39	59.25	32.5	46	25.75

# Ripplefold™ Stack Guide for Butt Master 84111xxx

Note: Stack size is estimated. Type of fabric used could alter these measurements. Please refer to the Ripplefold Fabrication Manual for more information.

120% Fullness	100% Fullness	80% Fullness	60% Fullness	Number of factory snaps	Snap Tape Length (less return length)*	Panel Stackback
13⅜	15⅜	17⅞	18⅞	8	32½	5½
17⅜	19⅝	21⅞	24⅞	10	41	6½
21⅞	23⅞	26⅝	29⅝	12	49½	7½
24⅞	28⅞	31⅞	34⅝	14	58	8¾
28⅝	32⅝	36⅞	39⅞	16	66½	9¾
32⅝	36⅝	40⅞	45⅞	18	75	11
36⅞	40⅞	45⅝	50⅞	20	83½	12
39⅞	45⅞	50⅝	55⅞	22	92	13
45⅝	49⅞	55⅞	60⅞	24	100½	14¼
47⅞	53⅞	59⅞	66⅞	26	109	15¼
51⅞	57⅞	64⅞	71⅞	28	117½	16½
54⅞	62⅞	69⅞	76⅞	30	126	17½
58⅝	66⅞	74⅞	81⅞	32	134½	18½
62⅞	70⅞	78⅞	87⅞	34	143	19¾
66⅞	74⅞	83⅝	92⅞	36	151½	20¾
69⅞	79⅞	88⅞	97⅞	38	160	22
73⅞	83⅞	93⅞	102⅞	40	168½	23
77⅞	87⅞	97⅞	108⅞	42	177	24
81⅞	91⅞	102⅝	113⅞	44	185½	25¼
84⅞	96⅞	107⅞	118⅞	46	194	26¼
88⅞	100⅞	112⅞	123⅞	48	202½	27½
92⅞	104⅝	116⅞	129⅞	50	211	28½
96⅞	108⅞	121⅞	134⅞	52	219½	29½
99⅞	113⅞	126⅞	139⅞	52	228	30¾
103⅝	117⅞	131⅞	144⅞	54	236½	31¾
107⅞	121⅞	135⅞	150⅞	56	245	33
111⅞	125⅞	140⅞	155⅞	58	253½	34
114⅞	130⅞	145⅞	160⅞	60	262	35
118⅞	134⅞	150⅞	165⅞	62	270½	36¼
122⅞	138⅞	154⅞	171⅞	64	279	37¼
126⅞	142⅞	159⅞	176⅞	66	287½	38½
129⅞	147⅞	164⅞	181⅞	68	296	39 ½
133⅝	151⅞	169⅞	186⅞	70	304½	40½
137⅞	155⅞	173⅞	192⅞	72	313	41¾
141⅞	159⅞	178⅞	197⅞	74	321½	42¾
144⅞	164⅞	183⅞	202⅞	76	330	44

# Ripplefold™ Stack Guide for Butt Master 8411xxx

Note: Stack size is estimated. Type of fabric used could alter these measurements. Please refer to the Ripplefold Fabrication Manual for more information.

120% Fullness	100% Fullness	80% Fullness	60% Fullness	Number of factory snaps	Snap Tape Length (less return length)*	Panel Stackback
148½%	168½%	188½%	207½%	78	338½	45
152¾%	176¾%	192¾%	213¾%	80	347	46
156½%	176¾%	197½%	218¾%	84	355½	47¼
159¾%	181½%	202¾%	223¾%	86	364	48¼
163¾%	185¾%	207½%	228¾%	88	372½	49½
167¾%	189¾%	211¾%	234½%	90	381	50½
171½%	193¾%	216¾%	239¾%	92	389½	51½
174¾%	198½%	221¾%	244¾%	94	398	52¾
178¾%	202¾%	226½%	249¾%	96	406½	53¾
182¾%	206¾%	230¾%	255½%	98	415	55
186½%	210¾%	235¾%	260¾%	100	423½	56
189¾%	215½%	240¾%	265¾%	102	432	57
193¾%	219¾%	245½%	270¾%	104	440½	58¼
197¾%	223¾%	249¾%	276½%	106	449	59¼
201½%	227¾%	254¾%	281¾%	108	457½	60½
204¾%	232½%	259¾%	286¾%	110	466	61½
208¾%	236¾%	264½%	291¾%	112	474½	62 ½
212¾%	240¾%	268¾%	297½%	114	483	63¾
216½%	244¾%	273¾%	302¾%	116	491½	64¾
219¾%	249½%	278¾%	307¾%	118	500	66
223¾%	253¾%	283½%	312¾%	120	508½	67
227¾%	257¾%	287¾%	318½%	122	517	68
231½%	261¾%	292¾%	323¾%	124	525½	69¼
234¾%	266½%	297¾%	328¾%	126	534	70¼
238¾%	270¾%	302½%	333¾%	128	542½	71½
242¾%	274¾%	306¾%	339½%	130	551	72½
246½%	278¾%	311¾%	344¾%	132	559½	73½
249¾%	283¾%	316¾%	349¾%	134	568	74¾
253¾%	287¾%	321½%	354¾%	136	576½	75¾
257¾%	291¾%	325¾%	360½%	138	585	77
261½%	295¾%	330¾%	365¾%	140	593½	78
264¾%	300¾%	335¾%	370¾%	142	602	79
268¾%	304¾%	340½%	375¾%	144	610½	80¼
272¾%	308¾%	344¾%	381½%	146	619	81¼
276½%	312¾%	349¾%	386¾%	148	627½	82½
279¾%	317¾%	354¾%	391½%	150	636	83½

# Ripplefold™ Stack Guide for Butt Master 84214xxx

Note: Stack size is estimated. Type of fabric used could alter these measurements. Please refer to the Ripplefold Fabrication Manual for more information.

120% Fullness	100% Fullness	80% Fullness	60% Fullness	Number of factory snaps	Snap Tape Length (less return length)*	Panel Stackback
14⅞	16⅜	17⅞	19⅜	8	32½	7½
18⅝	20⅝	22⅝	24⅝	10	41	8½
22⅜	24⅞	27⅜	29⅞	12	49½	9¾
26⅞	29⅞	32⅞	35⅞	14	58	10¾
29⅞	33⅜	36⅞	40⅜	16	66½	12
33⅝	37⅝	41⅝	45⅝	18	75	13
37⅜	41⅞	46⅜	50⅞	20	83½	14
41⅞	46⅞	51⅞	56⅞	22	92	15¼
44⅞	50⅜	55⅞	61⅜	24	100½	16¼
48⅝	54⅝	60⅞	66⅝	26	109	17½
52⅜	58⅞	65⅞	71⅞	28	117½	18½
56⅞	63⅞	70⅞	77⅞	30	126	19½
59⅞	67⅜	74⅞	82⅜	32	134½	20¾
63⅝	71⅞	79⅝	87⅝	34	143	21¾
67⅜	75⅞	84⅜	92⅞	36	151½	23
71⅞	80⅞	89⅞	98⅞	38	160	24
74⅞	84⅜	93⅞	103⅜	40	168½	25
78⅝	88⅝	98⅞	108⅝	42	177	26¼
82⅜	92⅞	103⅜	113⅜	44	185½	27¼
86⅞	97⅞	108⅞	119⅞	46	194	28½
89⅞	101⅜	112⅞	124⅜	48	202½	29½
93⅝	105⅝	117⅝	129⅝	50	211	30½
97⅜	109⅞	122⅜	134⅞	52	219½	31¾
101⅞	114⅞	127⅞	140⅞	54	228	32¾
104⅞	118⅜	131⅞	145⅜	56	236½	34
108⅝	122⅝	136⅝	150⅝	56	245	35
112⅜	126⅞	141⅜	155⅞	60	253½	36¼
116⅞	131⅞	146⅞	161⅞	62	262	37¼
119⅞	135⅜	150⅞	166⅜	64	270½	38¼
123⅜	139⅝	155⅞	171⅞	66	279	39½
127⅜	143⅞	160⅜	176⅞	68	287½	40½
131⅞	148⅞	165⅞	182⅞	70	296	41¾
134⅞	152⅜	169⅞	187⅜	72	304½	42¾
138⅝	156⅝	174⅝	192⅝	74	313	43¾
142⅜	160⅞	179⅜	197⅞	76	321½	45
146⅞	165⅞	184⅞	203⅞	78	330	46



# Ripplefold™ Stack Guide for Butt Master 84214xxx

Note: Stack size is estimated. Type of fabric used could alter these measurements. Please refer to the Ripplefold Fabrication Manual for more information.

120% Fullness	100% Fullness	80% Fullness	60% Fullness	Number of factory snaps	Snap Tape Length (less return length)*	Panel Stackback
149⅜	169⅜	188⅜	208⅜	80	338½	47¼
153⅜	173⅜	193⅜	213⅜	82	347	48¼
157⅜	177⅜	198⅜	218⅜	84	355½	49½
161⅜	182⅜	203⅜	224⅜	86	364	50½
164⅞	186⅜	207⅞	229⅞	88	372½	51½
168⅝	190⅝	212⅝	234⅝	90	381	52¾
172⅜	194⅞	217⅜	239⅞	92	389½	53¾
176⅜	199⅜	222⅜	245⅜	94	398	55
179⅞	203⅜	226⅞	250⅞	96	406½	56
183⅜	207⅜	231⅜	255⅜	98	415	57
187⅜	211⅞	236⅜	260⅞	100	423½	58¼
191⅜	216⅜	241⅜	266⅜	102	432	59¼
194⅞	220⅜	245⅞	271⅞	104	440½	60½
198⅝	224⅝	250⅝	276⅝	106	449	61½
202⅜	228⅞	255⅜	281⅞	108	457½	62½
206⅜	233⅜	260⅜	287⅜	110	466	63¾
209⅞	237⅜	264⅞	292⅞	112	474½	64¾
213⅝	241⅜	269⅝	297⅝	114	483	66
217⅜	245⅞	274⅜	302⅞	116	491½	67
221⅜	250⅜	279⅜	308⅜	118	500	68¼
224⅞	254⅜	283⅞	313⅞	120	508½	69¼
228⅝	258⅝	288⅝	318⅝	122	517	70¼
232⅜	262⅞	293⅜	323⅞	124	525½	71½
236⅜	267⅜	298⅜	329⅜	126	534	72½
239⅞	271⅜	302⅞	334⅞	128	542½	73¾
243⅝	275⅝	307⅝	339⅝	130	551	74¾
247⅜	279⅞	312⅜	344⅞	132	559½	75¾
251⅜	284⅜	317⅜	350⅜	134	568	77
254⅞	288⅜	321⅞	355⅞	136	576½	78
258⅝	292⅝	326⅝	360⅝	138	585	79¼
262⅜	296⅞	331⅜	365⅞	140	593½	80¼
266⅜	301⅜	336⅜	371⅜	142	602	81¼
269⅞	305⅜	340⅞	376⅞	144	610½	82½
273⅝	309⅝	345⅝	381⅝	146	619	83½
277⅜	313⅞	350⅞	386⅞	148	627½	84¾
281⅜	318⅜	355⅜	392⅜	150	636	85¾

# Ripplefold™ Overlap Stack Guide

Note: Stack size is estimated. Type of fabric used could alter these measurements. Please refer to the Ripplefold Fabrication Manual for more information.

120% Fullness	100% Fullness	80% Fullness	60% Fullness	Number of factory snaps	Snap Tape Length (less return length)*	Panel Stackback
16¼	17¾	19⅞	20¾	8	34	9
20	22	23⅞	26	10	42½	10¼
23¾	26¼	28⅞	31¼	12	51	11¼
27½	20½	33⅞	26½	14	59½	12½
31¼	34¾	38⅞	41¾	16	68	13½
35	39	42⅞	47	18	76½	14½
38¾	43¼	47⅞	52¼	20	85	15¾
42½	47½	52⅞	57½	22	93½	16¾
46¼	51¾	57⅞	62¾	24	102	18
50	56	61⅞	68	26	110½	19
53¾	60¼	66⅞	73¼	28	119	20
57½	64½	71⅞	78½	30	127½	21¼
61¼	68¾	76⅞	83¾	32	136	22¼
65	73	80⅞	89	34	144½	23½
68¾	77¼	85⅞	94¼	36	153	24½
72½	81½	90⅞	99½	38	161½	25½
76¼	85¾	95⅞	104¾	40	170	26¾
80	90	99⅞	110	42	178½	27¾
83¾	94¼	104⅞	115¼	44	187	29
87½	98½	109⅞	120½	46	195½	30
91¼	102¾	114⅞	125¾	48	204	31
95	107	118⅞	131	50	212½	32¼
98¾	111¼	123⅞	136¼	52	221	33¼
102½	115½	128⅞	141½	54	229½	34½
106¼	119¾	133⅞	146¾	56	238	35½
110	124	137⅞	152	56	246½	36½
113¾	128¼	142⅞	157¼	60	255	37¾
117½	132½	147⅞	162½	62	263½	38¾
121¼	136¾	152⅞	167¾	64	272	40
125	141	156⅞	173	66	280½	41
128¾	145¼	161⅞	178¼	68	289	42
132½	149½	166⅞	183½	70	297½	43¼
136¼	153¾	171⅞	188¾	72	306	44¼
140	158	175⅞	194	74	314½	45½
143¾	162¼	180⅞	199¼	76	323	46½
147½	166½	185⅞	204½	78	331½	47½











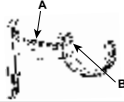





# Ripplefold™ Overlap Stack Guide













Note: Stack size is estimated. Type of fabric used could alter these measurements. Please refer to the Ripplefold Fabrication Manual for more information.

120% Fullness	100% Fullness	80% Fullness	60% Fullness	Number of factory snaps	Snap Tape Length (less return length)*	Panel Stackback
151¼	170¼	190½	209¾	80	340	48¾
155	175	194¾	215	82	348½	49¾
158¾	179¼	199½	220¼	84	357	51
162½	183½	204¾	225½	86	365½	52
166¼	187¾	209½	230¾	88	374	53
170	192	213¾	236	90	382½	54¼
173¾	196¼	218½	241¼	92	391	55¼
177½	200½	223¾	246½	94	399½	56½
181¼	204¾	228½	251¾	96	408	57½
185	209	232¾	257	98	416½	58½
188¾	213¼	237½	262¼	100	425	59¾
192½	217½	242¾	267½	102	433½	60¾
196¼	221¾	247½	272¾	104	442	62
200	226	251¾	278	106	450½	63
203¾	230¼	256½	283¼	108	459	64
207½	234½	261¾	288½	110	467½	65¼
211¼	238¾	266½	293¾	112	476	66¼
215	243	270¾	299	114	484½	67½
218¾	247¼	275½	304¼	116	493	68½
222½	251½	280¾	309½	118	501½	69½
226¼	255¾	285½	314¾	120	510	70¾
230	260	289¾	320	122	518½	71¾
233¾	264¼	294½	325¼	124	527	73
237½	268½	299¾	330½	126	535½	74
241¼	272¾	304½	335¾	128	544	75
245	277	308¾	341	130	552½	76¼
248¾	281¼	313½	346¼	132	561	77¼
252½	285½	318¾	351½	134	569½	78½
256¼	289¾	323½	356¾	136	578	79½
260	294	327¾	362	138	586½	80½
263¾	298¼	332½	367¼	140	595	81¾
267½	302½	337¾	372½	142	603½	82¾
271¼	306¾	342½	377¾	144	612	84
275	311	346¾	383	146	620½	85
278¾	315¼	351½	388¼	148	629	86
282½	319½	356¾	393½	150	637½	87¼

# 1 3/8" Decorative Bracket Weight Chart

Weight capacity shown is maximum per bracket when screwed into solid wood. Weight capacity is reduced when using wall anchors or screwing into other substrates. Consult a professional for the proper screw and wall anchor for your application as many factors affect the mounting strength.

<b>Wall Mount Bracket</b>		<b>Basic assembly</b> A) Tighten to 8 in lb B) Tighten leveling screw			
Not Extended	Extension Extended	Extension Not Extended	Extension Extended	Extension Not Extended	Extension Extended
Single Pole (1832074-1832081)		Single Pole (1832074-1832081) with extension (1832138-1832145)			
					
MAXIMUM: 25 LBS	MAXIMUM: 20 LBS	MAXIMUM: 20 LBS	MAXIMUM: 10 LBS		
Double pole (1832106-1832113)		Double pole (1832106-1832113) with extension (1832138-1832145)			
					
MAXIMUM: 25 LBS	MAXIMUM: 10 LBS	MAXIMUM: 10 LBS	MAXIMUM: 8 LBS		
Single pole bypass (1832090-1832097)		Single pole bypass (1832090-1832097) with extension (1832138-1832145)			
					
MAXIMUM: 25 LBS	MAXIMUM: 20 LBS	MAXIMUM: 20 LBS	MAXIMUM: 10 LBS		
Double pole bypass (1832122-1832129)		Double pole bypass (1832122-1832129) with extension (1832138-1832145)			
					
MAXIMUM: 12 LBS	MAXIMUM: 10 LBS	MAXIMUM: 10 LBS	MAXIMUM: 8 LBS		

<b>Ceiling Mount Bracket</b>		<b>Basic assembly</b> A) Tighten to 8 in lb B) Tighten leveling screw			
Not Extended	Extension Extended	Extension Not Extended	Extension Extended	Extension Not Extended	Extension Extended
Single pole (1832082-1832089)		Single pole (1832082-1832089) with extension(1832138-1832145)			
					
MAXIMUM: 25 LBS	MAXIMUM: 25 LBS	MAXIMUM: 25 LBS	MAXIMUM: 25 LBS		
Double pole (1832114-1832121)		Double pole (1832114-1832121) with extension (1832138-1832145)			
					
MAXIMUM: 25 LBS	MAXIMUM: 25 LBS	MAXIMUM: 25 LBS	MAXIMUM: 25 LBS		
Single pole bypass (1832098-1832105)		Single pole bypass (1832098-1832105) with extension (1832138-1832145)			
					
MAXIMUM: 25 LBS	MAXIMUM: 25 LBS	MAXIMUM: 25 LBS	MAXIMUM: 25 LBS		

# Pole Installation, Cutting & Splicing

## Top Hole Installation Guide

This chart will position the bracket so the drapery will clear the floor approximately ½".

1. Find your pole style, size and header style in the chart.
2. Determine the desired finished drapery length.
3. Add or subtract number in the top hole column from the drapery's finished length to determine how high to measure for the top hole of the bracket.

Stationary Poles			
	Rod Pocket (no top ruffle)	Pleated (any variety)	
	Top Hole	Top Hole	Pin Set
1½" Decorative Wall & Bypass Bracket	- $\frac{9}{16}$ "	+1 $\frac{7}{8}$ "	$\frac{1}{4}$ "
1½" Decorative Double & Bypass Bracket	- $\frac{9}{16}$ "	+1 $\frac{7}{8}$ "	$\frac{1}{4}$ "
1½" Decorative O Wall & O Bypass Bracket	- $\frac{3}{8}$ "	+2 $\frac{9}{16}$ "	$\frac{1}{4}$ "
1" Decorative O Wall & O Bypass Bracket	- $\frac{5}{16}$ "	+2"	$\frac{1}{4}$ "
1½" French Return	- $\frac{3}{8}$ "	+2 $\frac{9}{16}$ "	$\frac{1}{4}$ "
1" French Return	- $\frac{5}{16}$ "	+2"	$\frac{1}{4}$ "
1½" Standard Bracket	-1 $\frac{1}{4}$ "	+1 $\frac{3}{16}$ "	$\frac{1}{4}$ "

Wall Mount Traverse Rods					
	Pleated (any variety)			Ripplefold™ (any fullness)	
	Top Hole for Wall Mount	Floor to Ceiling Deduction	Suggested Pin Set	Top Hole for Wall Mount	Floor to Ceiling Deduction
1½" Estate™	+1 $\frac{11}{16}$ "	-2 $\frac{1}{8}$ "	$\frac{1}{2}$ "	+1 $\frac{11}{16}$ "	-2 $\frac{1}{8}$ "
2" Estate™	+1 $\frac{11}{16}$ "	-2 $\frac{13}{16}$ "	$\frac{1}{2}$ "	+1 $\frac{11}{16}$ "	-2 $\frac{13}{16}$ "

Ceiling Mount Traverse Rods					
1½" Estate™	+0"	-3 $\frac{5}{8}$ "	$\frac{1}{2}$ "	+0"	-3 $\frac{5}{8}$ "
2" Estate™	+0"	-3 $\frac{5}{8}$ "	$\frac{1}{2}$ "	+0"	-3 $\frac{5}{8}$ "

## Cutting & Splicing Designer Metals™ Poles

- Measure to desired length and carefully wrap area with an easy peel, blue painter's tape as not to damage the finish.
- Cut through the tape with sharp fine tooth saw. Cut slowly to reduce any chipping to the product finish.
- For spliced poles, add a finial plug to the end cut.
- Splice fits inside the pole and is specific to the pole diameter.



Finial Plug

1½" Diameter  
Part # 73405058



Splice

1" Diameter  
Part # 1042812  
1½" Diameter  
Part # 73304061

# Learn more about all of our collections



	<b>Designer Metals™ Collection</b>	<b>Wood Trends™ Collection</b>	<b>Wrought Iron Collection</b>	<b>Estate™ Traverse Rods Collection</b>
	sophisticated styles acrylic and metals striking finishes	crafted timelessness beautiful finishes classic designs	architectural statement remarkable history real wrought iron	form meets function innovative solutions customizable
<b>Available Diameters</b>	1" 1⅜" & 2"	1⅜" & 2"	1" & 1⅜"	1⅜" Wrought Iron  1⅜" & 2" Designer Metals™ Wood Trends™  2" Varia & Chroma
<b>Pole Lengths</b>	Fixed - 4', 6' & 8' Telescoping - 36"-180"	4', 6', 8', 12'	6' & 8'	18"-16'
<b>Pole Material</b>	Metal	Wood	Metal	Wood, Metal, Varia & Chroma
<b>Operation Modes</b>	Stationary, Traversing Manual or Motorized Draw	Stationary, Traversing Manual or Motorized Draw	Stationary, Traversing Manual or Motorized Draw	Traversing Manual or Motorized Draw
<b>Pole Sizing</b>	Fixed Width & Telescoping	Fixed Width	Fixed Width	Cut to Measure
<b>Finishes</b>	8	9	6	62
<b>Finials</b>	27	18	18	106
<b>Bracket Types</b>	Decorative Fixed & Bypass Fixed	Decorative Fixed	Decorative Fixed & Bypass Fixed	Concealed Adjustable
<b>Bracket Sizes</b>	3" – 8¾", Inside Mount & Ceiling Mount	3½" – 7", Inside Mount & Ceiling Mount	3½" – 6½" & Inside Mount	1¾" – 3¼"
<b>Treatment Styles</b>	Stationary & Traversing	Stationary & Traversing	Stationary & Traversing	Traversing



Designer Metals | 1" Soren in Gilded Bronze, Brushed Bronze & Elegant Brass



Wood Trends | Chaucer in Estate Oak, Black



Wrought Iron | Darby in Graphite, Heirloom Copper

PRODUCT NO.	PAGE	PRODUCT NO.	PAGE	PRODUCT NO.	PAGE	PRODUCT NO.	PAGE
1026660	26, 42	1042675	11	1042839	30	1042896	29
1026661	26, 42	1042676	11	1042840	30	1042897	29
1026662	26, 42	1042677	11	1042841	30	1042898	29
1026663	26, 42	1042678	11	1042842	30	1042899	29
1042051	19	1042679	11	1042843	30	1042900	29
1042052	19	1042680	11	1042844	30	1042901	29
1042053	19	1042681	11	1042845	30	1042902	29
1042054	19	1042682	11	1042846	30	1042903	29
1042055	19	1042684	11	1042847	30	1042904	29
1042057	19	1042685	11	1042848	30	1042905	29
1042058	19	1042686	11	1042849	30	1042906	29
1042059	19	1042687	11	1042850	30	1042907	29
1042257	23	1042706	29	1042851	30	1042908	29
1042258	23	1042707	29	1042852	30	1042909	29
1042259	23	1042708	29	1042853	30	1042910	29
1042592	30	1042709	29	1042854	16	1042911	29
1042593	30	1042760	28	1042855	16	1042912	29
1042594	30	1042761	28	1042856	16	1042913	29
1042595	30	1042762	28	1042857	16	1042914	29
1042596	30	1042763	12	1042858	16	1042915	29
1042597	30	1042764	12	1042859	16	1042916	29
1042598	30	1042765	12	1042860	16	1042917	29
1042599	30	1042766	12	1042861	16	1042918	13
1042605	28	1042767	12	1042862	16	1042919	13
1042606	28	1042768	12	1042863	16	1042920	13
1042607	28	1042769	12	1042864	16	1042921	13
1042608	28	1042770	12	1042865	16	1042922	13
1042609	28	1042771	12	1042866	16	1042923	13
1042650	23	1042772	12	1042867	16	1042924	13
1042651	23	1042773	12	1042868	16	1042925	13
1042652	23	1042774	12	1042869	16	1042926	13
1042653	23	1042775	12	1042870	16	1042927	13
1042654	23	1042776	12	1042871	16	1042928	13
1042655	23	1042777	12	1042872	16	1042929	13
1042656	23	1042778	12	1042873	16	1042930	13
1042657	23	1042779	12	1042874	16	1042931	13
1042658	23	1042780	12	1042875	16	1042932	13
1042659	23	1042781	12	1042876	16	1042933	13
1042660	23	1042782	12	1042877	16	1042934	13
1042661	23	1042783	12	1042878	16	1042935	13
1042662	23	1042784	12	1042879	16	1042936	13
1042663	11	1042785	12	1042880	16	1042937	13
1042664	11	1042786	12	1042881	16	1042938	13
1042665	11	1042812	11	1042882	16	1042939	13
1042666	11	1042830	30	1042883	16	1042940	13
1042667	11	1042831	30	1042884	16	1042941	13
1042668	11	1042832	30	1042885	16	1042942	13
1042669	11	1042833	30	1042890	29	1042943	13
1042670	11	1042834	30	1042891	29	1042944	13
1042671	11	1042835	30	1042892	29	1042945	13
1042672	11	1042836	30	1042893	29	1042946	13
1042673	11	1042837	30	1042894	29	1042947	13
1042674	11	1042838	30	1042895	29	1042948	13



PRODUCT NO.	PAGE	PRODUCT NO.	PAGE	PRODUCT NO.	PAGE	PRODUCT NO.	PAGE
1042949	13	1043004	8	1043901	18	1043964	43
1042950	19	1043005	8	1043902	18	1043965	35
1042951	19	1043006	8	1043903	19	1043969	25
1042952	19	1043007	8	1043904	20	1043970	42
1042953	19	1043008	9	1043905	20	1043994	27
1042954	19	1043009	9	1043906	20	1043995	27
1042955	19	1043010	9	1043907	35	1043996	27
1042956	19	1043011	9	1043908	24	1043997	27
1042957	19	1043012	9	1043909	24	1043998	27
1042958	17	1043013	9	1043910	24	1043999	27
1042959	17	1043014	9	1043911	23	1044000	27
1042960	17	1043015	9	1043912	35	1044001	27
1042961	17	1043016	9	1043913	27	1044002	27
1042962	17	1043017	9	1043915	37	1044003	27
1042963	17	1043018	9	1043916	37	1044004	27
1042964	17	1043019	9	1043917	37	1044005	27
1042965	17	1043020	9	1043918	37	1044006	27
1042966	19	1043021	9	1043919	38	1044007	27
1042967	19	1043022	9	1043920	43	1044008	27
1042968	19	1043023	9	1043921	35	1044009	27
1042969	19	1043025	9	1043926	25	1044010	12, 27
1042970	19	1043026	9	1043927	42	1044011	12, 27
1042971	19	1043027	9	1043929	34	1044012	12, 27
1042972	19	1043028	9	1043930	33	1044013	12, 27
1042973	19	1043029	9	1043931	32	1044014	12, 27
1042974	18	1043030	9	1043933	32	1044015	12, 27
1042975	18	1043031	9	1043934	32	1044016	12, 27
1042976	18	1043032	9	1043935	33	1044017	12, 27
1042977	18	1043033	8	1043937	33	1831267	24
1042978	18	1043034	8	1043938	33	1831269	24
1042979	18	1043035	8	1043939	32	1831412	43
1042980	18	1043036	8	1043940	22	1831416	43
1042981	18	1043037	8	1043941	22	1831417	43
1042982	17	1043038	8	1043943	17	1831418	43
1042983	17	1043039	8	1043944	18	1831419	43
1042984	17	1043040	8	1043945	18	1831421	35
1042985	17	1043041	17	1043946	18	1831425	35
1042986	17	1043042	17	1043947	19	1831426	35
1042988	17	1043043	8	1043948	20	1831427	35
1042989	17	1043044	8	1043949	20	1831428	35
1042990	17	1043885	34	1043950	20	1831451	24
1042991	8	1043886	33	1043951	35	1831452	24
1042992	8	1043887	32	1043952	24	1831456	24
1042993	8	1043889	32	1043953	24	1831458	24
1042994	8	1043890	32	1043954	24	1831459	24
1042995	8	1043891	33	1043955	23	1831460	24
1042996	8	1043893	33	1043956	35	1831461	24
1042997	8	1043894	33	1043957	27	1831465	24
1042999	8	1043895	32	1043959	37	1831467	24
1043000	8	1043896	22	1043960	37	1831468	24
1043001	8	1043897	22	1043961	37	1831469	24
1043002	8	1043899	17	1043962	37	1831470	24
1043003	8	1043900	18	1043963	38	1831542	27

PRODUCT NO.	PAGE	PRODUCT NO.	PAGE	PRODUCT NO.	PAGE	PRODUCT NO.	PAGE
1831546	27	1831994	37	1832128	33	1832222	35
1831547	27	1831995	37	1832129	33	1832224	35
1831548	27	1831999	37	1832138	33	1832225	35
1831549	27	1832001	37	1832139	33	1832226	25
1831551	35	1832002	37	1832140	33	1832227	25
1831555	35	1832003	37	1832142	33	1832228	25
1831556	35	1832004	37	1832144	33	1832230	25
1831557	35	1832008	37	1832145	33	1832232	25
1831558	35	1832019	23	1832146	18	1832233	25
1831559	35	1832020	23	1832147	18	1832234	42
1831598	20	1832021	23	1832148	18	1832235	42
1831599	20	1832022	23	1832150	18	1832236	42
1831631	24	1832026	23	1832152	18	1832238	42
1831634	20	1832074	32	1832153	18	1832240	42
1831635	20	1832075	32	1832154	22	1832241	42
1831663	20	1832076	32	1832155	22	1858568	34
1831705	19	1832078	32	1832156	22	1858569	34
1831706	19	1832080	32	1832158	22	1858570	34
1831707	19	1832081	32	1832160	22	1858572	34
1831708	19	1832082	32	1832161	22	1858574	34
1831712	19	1832083	32	1832162	22	1930946	37
1831715	18	1832084	32	1832163	22	54780058	36
1831717	18	1832086	32	1832164	22	62101000	26, 42
1831883	20	1832088	32	1832166	22	62101010	26, 42
1831884	20	1832089	32	1832168	22	62102000	26, 42
1831885	20	1832090	32	1832169	22	62108000	26, 42
1831886	20	1832091	32	1832170	18	62109000	26, 42
1831890	20	1832092	32	1832171	18	62201300	26, 42
1831904	17	1832094	32	1832172	18	71132006	26, 43
1831905	17	1832096	32	1832174	18	71132012	26, 43
1831906	17	1832097	32	1832176	18	71132062	26, 43
1831907	17	1832098	32	1832177	18	71132110	26, 43
1831921	17	1832099	32	1832186	20	71134110	25, 43
1831952	37	1832100	32	1832187	20	73304061	36
1831957	17	1832102	32	1832188	20	73405058	35
1831958	18	1832104	32	1832190	20	83687867	25
1831960	18	1832105	32	1832192	20	83687919	25
1831962	18	1832106	33	1832193	20	83687920	25
1831963	18	1832107	33	1832202	37	83687922	25
1831966	19	1832108	33	1832203	37	83687923	25
1831967	20	1832110	33	1832204	37	83687924	25
1831968	20	1832112	33	1832206	37	83687925	25
1831977	24	1832113	33	1832208	37	83687926	25
1831978	24	1832114	33	1832209	37	83688867	25
1831979	24	1832115	33	1832210	38	83688919	25
1831980	37	1832116	33	1832211A	38	83688920	25
1831981	37	1832118	33	1832212	38	83688922	25
1831982	37	1832120	33	1832214	38	83688923	25
1831983	37	1832121	33	1832216	38	83688924	25
1831984	37	1832122	33	1832217	38	83688925	25
1831988	37	1832123	33	1832218	35	83688926	25
1831992	37	1832124	33	1832219	35	84990000	36
1831993	37	1832126	33	1832220	35	93685867	40

PRODUCT NO.	PAGE
93685919	40
93685920	40
93685922	40
93685923	40
93685924	40
93685925	40
93685926	40
93686867	40
93686919	40
93686920	40
93686922	40
93686923	40
93686924	40
93686925	40
93686926	40
1831413PN	43
1831422PN	35
1831543PN	27
1832023PN	23



**Designer Metals™**  
inspiring brilliance

**Wood Trends™**  
renewing traditions

**Wrought Iron**  
forging artistry

**Custom Rodding  
& Basic Hardware**  
unique solutions