



ROMAN SHADES PRICE GUIDE
2010



The West Lake Collection
Naturally Beautiful



Natural Woven Materials Reference [A - M]

PATTERN NAME	COLOR	NUMBER	PRICE GROUP	EDGE BINDING	WOOD BAR	RECOMMENDED WOOD BAR COLOR	FOLDING DOOR & DRAPERY
Abaca	Beige	WL 8811B	D	Y ²	Y	Sugar Maple/WB15	N
Abaca	Brown	WL 7230B	D	Y ²	Y	Walnut/WB03	Y
Abaca	Red Earth	WL 8811R	D	Y ²	Y	Spice/WB10	N
Abaca	Sage	WL 8813S	D	Y ²	Y	Driftwood/WB05	Y
Acacia ¹	Natural	WL 5077N	A	Y	Y	Natural/WB06	Y
Akita	Carbon	WL 3100R	C	Y	Y	Sugar Maple/WB15	Y
Akita ¹	Cherry	WL 3060C	C	Y	Y	Spice/WB10	Y
Akita ¹	Gold	WL 3080G	C	Y	Y	Sugar Maple/WB15	Y
Akita	Hazelnut	WL 3030H	C	Y	Y	Espresso/WB14	Y
Akita	Oak	WL 3010K	C	Y	Y	Walnut/WB03	Y
Akita	Walnut	WL 3050W	C	Y	Y	Walnut/WB03	Y
Alina	Natural	WL 1020N	B	Y	Y	Natural/WB06	Y
Aurora	Cherry	WL 3200C	B	Y	Y	Spice/WB10	Y
Aurora	Walnut	WL 5186W	B	Y	Y	Walnut/WB03	Y
Bamboo Palm	Carbon	WL 4100R	C	Y	Y	Driftwood/WB05	Y
Bamboo Palm	Dark Oak	WL 4100D	C	Y	Y	Spice/WB10	Y
Bamboo Palm	Espresso	WL 4100E	C	Y	Y	Espresso/WB14	Y
Bamboo Palm	Walnut	WL 4100W	C	Y	Y	Spice/WB10	Y
Bamboo Reeds	Wheat	WL 2040W	B	N	Y	Natural/WB06	N
Bamboo Weave	Camel	WL 2060C	B	N	Y	Sugar Maple/WB15	N
Bora Bora	Natural	WL 8861N	B	Y	Y	Natural/WB06	Y
Borneo	Dappled	WL 7291D	B	Y	Y	Sugar Maple/WB15	Y
Cabana	Pecan	WL 8036P	B	Y	Y	Spice/WB10	Y
Cabana	Saddle	WL 8036S	B	Y	Y	Sugar Maple/WB15	Y
Calypso	Spring	WL 7231S	C	Y	Y	Sugar Maple/WB15	Y
Caribe	Spice	WL 5243S	D	Y ²	Y	Walnut/WB03	N
Chibo ¹	Natural	WL 1162N	A	Y	Y	Natural/WB06	Y
Driftwood	Natural	WL 5068N	A	Y	Y	Natural/WB06	Y
Forest Grass	Sage	WL 0235S	C	Y ²	Y	Driftwood/WB05	N
Harmony	Natural	WL 4970N	D	Y ²	Y	Natural/WB06	N
Harmony	Spice	WL 4970S	D	Y ²	Y	Walnut/WB03	N
Java ¹	Honey	WL 0505H	A	Y	Y	Sugar Maple/WB15	Y
Kyoto	Brown	WL 5646B	A	Y	Y	Walnut/WB03	Y
Kyoto	Merlot	WL 5647M	A	Y	Y	Spice/WB10	Y
Laguna	Umber	WL 8867U	A	N	Y	Sugar Maple/WB15	N
Lattice	Twilight	WL 8074D	A	Y	Y	Espresso/WB14	Y
Madras ¹	Sesame	WL 2530S	D	Y	Y	Sugar Maple/WB15	Y
Mandalay	Oak	WL 5087K	A	Y	Y	Sugar Maple/WB15	Y
Mandalay	Pistachio	WL 5052P	A	Y	Y	Natural/WB06	Y
Medan	Carmel	WL 5056C	A	Y	Y	Sugar Maple/WB15	Y
Monsoon ¹	Sand	WL 3910S	D	N	Y	Natural/WB03	N
Monterey	Oak	WL 6941K	A	Y	Y	Sugar Maple/WB15	Y

Natural Woven Materials Reference [N – W]

PATTERN NAME	COLOR	NUMBER	PRICE GROUP	EDGE BINDING	WOOD BAR	RECOMMENDED WOOD BAR COLOR	FOLDING DOOR & DRAPERY
Nikko ¹	Autumn	WL 5174A	B	Y	Y	Natural/WB06	Y
Nikko ¹	Summer	WL 5174S	B	Y	Y	Natural/WB06	Y
Nocturne	Ebony	WL 5186E	B	Y	Y	Natural/WB06	Y
Parchment	Bleached	WL 7253B	C	Y ²	Y	Natural/WB06	N
Parchment ¹	Sunset	WL 1206S	C	Y ²	Y	Sugar Maple/WB15	N
Penang	Oak	WL 5057K	A	Y	Y	Sugar Maple/WB15	Y
Prairie	Brushwood	WL 0209B	C	Y ²	Y	Walnut/WB03	N
Prairie	Natural	WL 7249N	D	Y ²	Y	Driftwood/WB05	N
Prairie	Russet	WL 7254R	D	Y ²	Y	Spice/WB10	N
Prairie ¹	Tan	WL 7250T	D	Y ²	Y	Sugar Maple/WB15	N
Raffia	Bark	WL 7252B	D	Y ²	Y	Walnut/WB03	N
Raffia	Sand	WL 7252S	D	Y ²	Y	Natural/WB06	N
River Cane	Sage	WL 5016S	D	Y	Y	Sugar Maple/WB15	Y
Rustic	Pecan	WL 8021P	A	Y	Y	Walnut/WB03	N
Rustic ¹	Saddle	WL 1003S	B	Y	Y	Sugar Maple/WB15	Y
Rustic	Tan	WL 8017T	A	Y	Y	Sugar Maple/WB15	N
St. Martin	Cappuccino	WL 8031C	D	Y	Y	Walnut/WB03	Y
Sakura ¹	Beige	WL 5052B	D	Y ²	Y	Sugar Maple/WB15	N
Samoa	Cinnamon	WL 4895S	C	Y	Y	Sugar Maple/WB15	Y
Savanna	Nightshade	WL 7415N	D	Y ²	Y	Espresso/WB14	N
Sedona ¹	Tan	WL 7290T	C	Y	Y	Sugar Maple/WB15	Y
Sisal	Natural	WL 5151N	D	Y	Y	Driftwood/WB05	Y
Sumatra	Espresso	WL 5002E	B	Y	Y	Espresso/WB14	N
Sumatra	Saddle	WL 5002S	B	Y	Y	Walnut/WB03	N
Sun Shade	Brown	WL 5049B	B	Y	Y	Walnut/WB03	Y
Sun Shade	Natural	WL 5049N	B	Y	Y	Natural/WB06	Y
Sun Shade	White	WL 5049W	C	Y	Y	Natural/WB06	N
Sunflower	Gold	WL 5106G	A	Y	Y	Sugar Maple/WB15	Y
Tamarind	Brown	WL 7248B	C	Y	Y	Spice/WB10	Y
Tiki	Carbon	WL 0120C	A	Y	Y	Walnut/WB03	Y
Tropical Wood ¹	Balsa	WL 1167B	B	Y	Y	Natural/WB06	Y
Tropical Wood ¹	Maroon	WL 1167M	B	Y	Y	Spice/WB10	Y
Westport	Nutmeg	WL 8865N	B	Y ²	Y	Spice/WB10	N
Woodweave ¹	Natural	WL 8028N	D	Y	Y	Natural/WB06	Y

1. These patterns are discontinued in 2010 sample book. They will be supported through 2010.

2. These patterns have a high jute or paper content. Edge binding can cause some stretching or warping with these patterns on wide shades.

Color Reference

Edge Binding Color Reference

FABRIC COLOR NAME	COLOR NUMBER
Ecru	EB1
Beige	EB2
Mocha	EB3
Camel	EB4
Sage	EB5
Chocolate	EB6
Harbor Grey	EB7
Smoke	EB8
Leaf Green	EB9
Black	EB10
Brick	EB11
Raspberry	EB12

Liner Color Reference

LINER COLOR NAME	COLOR NUMBER
Privacy Natural	FL4
Privacy Beige	FL8
Privacy Chocolate	FL3
Black-Out Soft White	FL9
Black-Out Beige	FL2
Black-Out Chocolate	FL1

Wood Bar Color Reference

WOOD BAR COLOR NAME	COLOR NUMBER
Walnut	WB03
Driftwood	WB05
Natural	WB06
Spice	WB10
Espresso	WB14
Sugar Maple	WB15

Shade Styles

1] Standard Roman Shade

Shade is raised by means of cords, which hang in front of the shade. Includes a 6-inch valance to conceal the components. When raised, the material rises from the bottom in flat folds.

2] Waterfall Shade

Shade is raised by means of cords, which hang behind the shade. Material is attached to the front of the head rail, without a valance. When raised, the material rises from the bottom in flat folds.

3] Twin Shade

Features two separate, independently operated shades on one head rail. The front shade can be either a standard or waterfall natural woven shade.

A separate liner shade is attached to the back of the head rail and both shades operate independently. Lift cords can be on the same side or opposite side of the shade.

Available with Roll Ease® clutch control for the front, natural woven shade or for both shades. See specifications for headrail sizes.



1] Standard



2] Waterfall
Shown with optional wood bottom bar.



Shown with cords on same side.



Shown with cords on opposite sides.

3] Twin Shade (in Standard Style)
Shown with optional wood bottom bar.

No Charge Options

Valance returns supplied with all outside mount shades. They also are available on request with inside mount shades. An extra ¼" deduction will be made to IM shades with valance returns.

Hold down brackets supplied upon request (not available with edge binding or wood bottom bars).

Spacer blocks are available upon request.

Extra Charge Options

Pricing for all Extra Charge Options can be obtained by pricing the shade and then adding the appropriate price from the Surcharge Charts for the chosen options. All prices in the Surcharge Charts are retail surcharges.

Cut Outs

Cut Outs can be taken from either side of the shade. Please provide exact dimensions and the locations of cut outs required.

There may be limitations to what can be cut out, based upon the size and specifications of the shade. The factory will review all orders for cut outs and provide confirmation of each order within 24 hours.

Cut Outs are not available with edge binding.

Clutch Control and Continuous Cord Loop

Clutch controls are available with all shade styles. Clutch controls are not available with Top Down Bottom Up.

Available on all sizes of shades.

Shades with clutch controls will be shipped without cord cleats, but with a RollEase® cord safety clip.

Shades with clutch controls will be mounted on a wider head rail (see Specifications for details).

Cord loops are dyed to coordinate with the color of the shade.

Edge Binding

Check **Materials Reference** for availability with each pattern. Fabric Edge Binding, 3 inches in width, (1½" on face of shade) will be applied to the sides of the shade and valance (if applicable) and across the bottom of the shade. Not available with Wood Bottom Bar. Not available with hold down brackets.

Liners

Available in Privacy or Black-Out liner.

Available with Wood Bottom Bar and Edge Binding. Liners are secured to the back of the shade by stitches at each side of the liner.

Privacy liners feature sewn-in ribs to give the liner the appearance of a finished roman shade.



Standard Shade
with Continuous Cord Loop



Standard Shade
with Edge Binding

Extra Charge Options

Lined Valance

Lined valances are recommended to conceal the head rail components, where an open-weave pattern is selected. This is particularly recommended if clutch controls are chosen or for Top Down Bottom Up Shades, as these components are more visible through the valance. We recommend lined valances for the following patterns:

Acacia	Alina	Cabana	Chibo	Nocturne	Sakura	Tropical Wood
Akita	Aurora	Caribe	Nikko	Rustic	Samoa	

Lined valances will always be made with Privacy Beige Liner (FL8) unless otherwise specified. If the shade is lined, the lined valance will be made with matching liner color.

We recommend that Waterfall Shades made with clutch controls in these patterns should be ordered fully lined.

Lined valances may also be ordered for standard shades with cord locks, if desired, to completely conceal the head rail components.

Multiple Shades on One Head Rail

Shades can be ordered two-on-one head rail, or three-on-one head rail, up to a maximum width of 120 inches. The width limit for a common valance is 96 inches.

Normal inside mount deductions will be made and there will be a maximum ½ inch gap between shades.

Top Down Bottom Up Shades

Shade can be raised from the bottom or lowered from the top, by two sets of cords on opposite sides of the shade. Includes a 6-inch valance to conceal the components. When raised, the material rises from the bottom in flat folds. Available with Liners, Wood Bottom Bars and Edge Bindings.

We recommend lining the valance on the Top Down Bottom Up Shades to conceal the components and any light gap which may be visible at the top of the shade.

Wood Bottom Bar

Available with all patterns and up to 96" wide. Not available with Edge Binding. Select your own color, or choose our recommended color to coordinate with your shade fabric. Tassels will be coordinated to the pattern and cords, not to the Wood Bar.



Top Down Bottom Up

Standard Shade Pricing

Includes Standard Roman Shade and Waterfall Shade



WIDTH

Price Group A	LENGTH	24"	30"	36"	42"	48"	60"	72"	84"	96"
		36"	\$94	\$119	\$145	\$162	\$180	\$222	\$250	\$291
Acacia	48"	\$132	\$152	\$171	\$194	\$214	\$267	\$299	\$350	\$386
Chibo	54"	\$141	\$171	\$185	\$207	\$234	\$290	\$330	\$378	\$421
Driftwood	60"	\$149	\$178	\$200	\$222	\$244	\$309	\$362	\$406	\$456
Java	66"	\$157	\$185	\$214	\$237	\$263	\$353	\$389	\$448	\$504
Kyoto	72"	\$165	\$196	\$228	\$253	\$279	\$369	\$410	\$491	\$551
Laguna	78"	\$176	\$209	\$242	\$273	\$304	\$392	\$444	\$520	\$586
Lattice	84"	\$186	\$222	\$257	\$291	\$330	\$415	\$468	\$551	\$628
Mandalay	90"	\$195	\$233	\$271	\$307	\$345	\$449	\$522	\$594	\$675
Medan	96"	\$204	\$245	\$286	\$324	\$362	\$473	\$542	\$632	\$720
Monterey	108"	\$230	\$276	\$322	\$365	\$407	\$532	\$609	\$711	\$810
Penang										
Rustic Pecan										
Rustic Tan										
Sunflower										
Tiki										

Price Group B	LENGTH	24"	30"	36"	42"	48"	60"	72"	84"	96"
		36"	\$128	\$155	\$182	\$198	\$214	\$250	\$285	\$335
Alina	48"	\$170	\$196	\$222	\$244	\$266	\$303	\$342	\$406	\$475
Aurora	54"	\$177	\$207	\$236	\$261	\$285	\$328	\$371	\$441	\$510
Bamboo Reeds	60"	\$186	\$218	\$250	\$277	\$303	\$353	\$400	\$475	\$545
Bamboo Weave	66"	\$196	\$231	\$265	\$294	\$323	\$377	\$430	\$507	\$579
Bora Bora	72"	\$206	\$243	\$280	\$311	\$342	\$400	\$460	\$539	\$612
Borneo	78"	\$215	\$255	\$295	\$329	\$362	\$425	\$489	\$570	\$648
Cabana	84"	\$224	\$267	\$309	\$345	\$381	\$450	\$518	\$601	\$683
Nikko	90"	\$235	\$280	\$324	\$362	\$400	\$485	\$560	\$648	\$733
Nocturne	96"	\$245	\$305	\$338	\$379	\$419	\$520	\$602	\$694	\$783
Rustic Saddle	108"	\$276	\$329	\$380	\$426	\$471	\$585	\$677	\$781	\$880
Sumatra										
Sunshade Stains										
Tropical Wood										
Westport										

Price Group C	LENGTH	24"	30"	36"	42"	48"	60"	72"	84"	96"
		36"	\$157	\$181	\$204	\$217	\$243	\$301	\$351	\$429
Akita	48"	\$177	\$206	\$234	\$252	\$270	\$349	\$407	\$492	\$582
Bamboo Palm	54"	\$189	\$220	\$251	\$272	\$292	\$369	\$446	\$536	\$614
Calypso	60"	\$201	\$234	\$267	\$290	\$319	\$401	\$470	\$563	\$661
Forest Grass	66"	\$213	\$248	\$282	\$307	\$342	\$433	\$510	\$609	\$708
Parchment	72"	\$224	\$261	\$297	\$324	\$361	\$471	\$554	\$660	\$765
Prairie Brushwood	78"	\$236	\$275	\$314	\$349	\$392	\$499	\$586	\$698	\$810
Samoa	84"	\$247	\$289	\$330	\$373	\$415	\$526	\$618	\$735	\$855
Sedona	90"	\$258	\$302	\$346	\$391	\$435	\$562	\$659	\$781	\$908
Sunshade White	96"	\$269	\$316	\$362	\$409	\$463	\$597	\$710	\$834	\$961
Tamarind	108"	\$303	\$356	\$407	\$460	\$521	\$672	\$799	\$938	\$1081

Price Group D	LENGTH	24"	30"	36"	42"	48"	60"	72"	84"	96"
		36"	\$188	\$216	\$243	\$260	\$276	\$351	\$409	\$497
Abaca	48"	\$214	\$242	\$281	\$303	\$325	\$413	\$484	\$583	\$682
Caribe	54"	\$227	\$268	\$309	\$329	\$349	\$442	\$521	\$625	\$732
Harmony	60"	\$240	\$289	\$327	\$355	\$373	\$472	\$558	\$668	\$780
Madras	66"	\$254	\$301	\$347	\$372	\$397	\$539	\$620	\$730	\$850
Monsoon	72"	\$268	\$312	\$356	\$389	\$422	\$566	\$666	\$793	\$919
Prairie	78"	\$279	\$327	\$375	\$471	\$459	\$598	\$704	\$838	\$972
Raffia	84"	\$295	\$344	\$394	\$445	\$496	\$630	\$742	\$880	\$1025
River Cane	90"	\$309	\$362	\$414	\$467	\$520	\$679	\$819	\$972	\$1126
St. Martin	96"	\$323	\$379	\$434	\$476	\$545	\$729	\$858	\$1019	\$1179
Sakura	108"	\$363	\$426	\$488	\$536	\$613	\$820	\$965	\$1146	\$1326
Savanna										
Sisal										
Woodweave										

Twin Shade Pricing | Privacy Liner

		WIDTH											
		24"	30"	36"	42"	48"	60"	72"	84"	96"			
Price Group A	LENGTH	36"	\$160	\$186	\$213	\$239	\$279	\$339	\$412	\$466	\$519		
		48"	\$173	\$200	\$226	\$266	\$306	\$372	\$440	\$519	\$559		
		54"	\$186	\$213	\$247	\$293	\$346	\$419	\$495	\$577	\$660		
		60"	\$200	\$229	\$275	\$321	\$379	\$452	\$550	\$641	\$733		
		66"	\$213	\$252	\$302	\$353	\$403	\$499	\$605	\$705	\$806		
		72"	\$226	\$275	\$330	\$385	\$440	\$550	\$660	\$769	\$879		
		78"	\$239	\$298	\$357	\$417	\$476	\$595	\$715	\$834	\$953		
		84"	\$259	\$321	\$385	\$449	\$513	\$632	\$769	\$898	\$1026		
		90"	\$273	\$339	\$412	\$481	\$539	\$678	\$824	\$962	\$1099		
		96"	\$293	\$359	\$439	\$513	\$559	\$705	\$879	\$1037	\$1197		
		108"	\$330	\$403	\$494	\$577	\$629	\$793	\$989	\$1167	\$1347		
		Price Group B	LENGTH	36"	\$179	\$227	\$268	\$316	\$358	\$447	\$537	\$632	\$710
				48"	\$197	\$245	\$286	\$340	\$382	\$471	\$561	\$668	\$752
54"	\$233			\$268	\$310	\$364	\$400	\$495	\$591	\$698	\$800		
60"	\$257			\$286	\$334	\$382	\$436	\$519	\$621	\$734	\$841		
66"	\$274			\$310	\$358	\$406	\$459	\$550	\$668	\$782	\$895		
72"	\$292			\$328	\$382	\$430	\$483	\$600	\$728	\$847	\$960		
78"	\$310			\$346	\$400	\$455	\$520	\$650	\$780	\$910	\$1040		
84"	\$328			\$364	\$424	\$490	\$560	\$700	\$847	\$980	\$1120		
90"	\$346			\$382	\$450	\$525	\$600	\$750	\$900	\$1050	\$1200		
96"	\$364			\$406	\$480	\$560	\$640	\$800	\$960	\$1120	\$1280		
108"	\$410			\$457	\$540	\$630	\$720	\$900	\$1080	\$1260	\$1440		
Price Group C	LENGTH			36"	\$219	\$265	\$302	\$347	\$389	\$539	\$662	\$810	\$920
				48"	\$232	\$275	\$312	\$351	\$400	\$542	\$687	\$829	\$935
		54"	\$248	\$285	\$330	\$379	\$410	\$557	\$710	\$848	\$963		
		60"	\$278	\$307	\$357	\$400	\$458	\$590	\$729	\$871	\$1020		
		66"	\$298	\$333	\$381	\$424	\$486	\$631	\$793	\$939	\$1094		
		72"	\$318	\$352	\$405	\$448	\$510	\$707	\$877	\$1039	\$1200		
		78"	\$341	\$373	\$426	\$482	\$563	\$763	\$934	\$1114	\$1300		
		84"	\$362	\$394	\$452	\$530	\$610	\$817	\$1012	\$1199	\$1402		
		90"	\$380	\$412	\$480	\$567	\$652	\$869	\$1059	\$1265	\$1486		
		96"	\$400	\$439	\$514	\$604	\$707	\$917	\$1132	\$1345	\$1570		
		108"	\$450	\$495	\$578	\$680	\$796	\$1034	\$1275	\$1513	\$1769		
		Price Group D	LENGTH	36"	\$263	\$316	\$359	\$415	\$460	\$629	\$772	\$938	\$1042
				48"	\$281	\$331	\$364	\$432	\$478	\$642	\$793	\$959	\$1098
54"	\$298			\$348	\$406	\$459	\$490	\$667	\$830	\$989	\$1148		
60"	\$332			\$380	\$437	\$489	\$536	\$694	\$866	\$1033	\$1204		
66"	\$356			\$404	\$469	\$513	\$565	\$786	\$964	\$1125	\$1314		
72"	\$381			\$421	\$485	\$537	\$596	\$849	\$1054	\$1247	\$1440		
78"	\$403			\$444	\$508	\$632	\$659	\$914	\$1123	\$1337	\$1559		
84"	\$434			\$469	\$541	\$651	\$728	\$979	\$1215	\$1435	\$1681		
90"	\$455			\$494	\$575	\$677	\$780	\$1050	\$1316	\$1575	\$1842		
96"	\$481			\$527	\$616	\$703	\$832	\$1121	\$1368	\$1643	\$1927		
108"	\$539			\$592	\$693	\$793	\$937	\$1262	\$1539	\$1849	\$2170		

Twin Shade Pricing | Black-Out Liner



		WIDTH											
		24"	30"	36"	42"	48"	60"	72"	84"	96"			
Price Group A	LENGTH	36"	\$172	\$201	\$230	\$259	\$302	\$366	\$445	\$503	\$560		
		48"	\$187	\$215	\$244	\$287	\$330	\$402	\$475	\$560	\$603		
		54"	\$201	\$230	\$267	\$316	\$373	\$452	\$534	\$623	\$712		
		60"	\$215	\$247	\$297	\$346	\$409	\$488	\$594	\$693	\$791		
		66"	\$230	\$272	\$326	\$381	\$435	\$539	\$653	\$762	\$871		
		72"	\$244	\$297	\$356	\$416	\$475	\$594	\$712	\$831	\$950		
		78"	\$259	\$322	\$386	\$450	\$514	\$643	\$772	\$900	\$1029		
		84"	\$280	\$346	\$416	\$485	\$554	\$682	\$831	\$970	\$1108		
		90"	\$294	\$366	\$445	\$519	\$582	\$733	\$890	\$1039	\$1187		
		96"	\$316	\$388	\$474	\$554	\$603	\$761	\$950	\$1120	\$1293		
		108"	\$356	\$437	\$533	\$623	\$678	\$856	\$1069	\$1260	\$1455		
		Price Group B	LENGTH	36"	\$193	\$245	\$290	\$342	\$387	\$483	\$580	\$683	\$767
				48"	\$213	\$264	\$309	\$367	\$412	\$509	\$606	\$722	\$812
54"	\$251			\$290	\$335	\$393	\$432	\$535	\$638	\$754	\$863		
60"	\$277			\$309	\$361	\$412	\$470	\$561	\$670	\$793	\$909		
66"	\$296			\$335	\$387	\$438	\$496	\$594	\$722	\$844	\$967		
72"	\$316			\$354	\$412	\$464	\$522	\$648	\$786	\$915	\$1036		
78"	\$335			\$374	\$432	\$491	\$561	\$702	\$842	\$982	\$1123		
84"	\$354			\$393	\$458	\$529	\$605	\$756	\$915	\$1058	\$1209		
90"	\$374			\$412	\$486	\$567	\$648	\$810	\$972	\$1134	\$1296		
96"	\$393			\$438	\$518	\$605	\$691	\$864	\$1036	\$1209	\$1382		
108"	\$442			\$493	\$583	\$680	\$777	\$972	\$1166	\$1360	\$1555		
Price Group C	LENGTH			36"	\$237	\$286	\$306	\$347	\$419	\$568	\$705	\$849	\$994
				48"	\$251	\$298	\$326	\$379	\$429	\$585	\$720	\$874	\$1006
		54"	\$268	\$308	\$356	\$410	\$442	\$602	\$767	\$916	\$1040		
		60"	\$300	\$332	\$385	\$432	\$495	\$637	\$787	\$940	\$1102		
		66"	\$322	\$360	\$411	\$458	\$525	\$682	\$856	\$1014	\$1182		
		72"	\$344	\$381	\$437	\$483	\$550	\$763	\$948	\$1122	\$1296		
		78"	\$368	\$403	\$460	\$521	\$608	\$824	\$1009	\$1203	\$1404		
		84"	\$391	\$425	\$489	\$572	\$658	\$883	\$1093	\$1295	\$1514		
		90"	\$410	\$445	\$519	\$612	\$704	\$938	\$1143	\$1366	\$1605		
		96"	\$432	\$474	\$555	\$652	\$764	\$990	\$1223	\$1453	\$1696		
		108"	\$485	\$533	\$624	\$734	\$859	\$1117	\$1376	\$1633	\$1910		
		Price Group D	LENGTH	36"	\$284	\$341	\$371	\$448	\$497	\$676	\$834	\$1014	\$1079
				48"	\$303	\$356	\$398	\$456	\$504	\$693	\$856	\$1035	\$1167
54"	\$322			\$375	\$439	\$495	\$529	\$721	\$896	\$1068	\$1239		
60"	\$358			\$410	\$472	\$529	\$579	\$770	\$935	\$1116	\$1300		
66"	\$384			\$437	\$506	\$554	\$610	\$849	\$1041	\$1215	\$1419		
72"	\$411			\$455	\$524	\$580	\$643	\$916	\$1138	\$1347	\$1556		
78"	\$435			\$479	\$549	\$604	\$712	\$987	\$1212	\$1444	\$1684		
84"	\$468			\$506	\$584	\$682	\$787	\$1057	\$1312	\$1550	\$1816		
90"	\$491			\$533	\$621	\$731	\$842	\$1134	\$1421	\$1701	\$1989		
96"	\$519			\$569	\$665	\$759	\$899	\$1211	\$1478	\$1775	\$2081		
108"	\$581			\$638	\$749	\$856	\$1011	\$1362	\$1662	\$1996	\$2343		

Shade Surcharges Option Pricing

Add the surcharge below to the retail price for the basic shade.

		WIDTH									
		24"	30"	36"	42"	48"	60"	72"	84"	96"	
Edge Binding Ecru Beige Mocha Camel Sage Chocolate Harbor Grey Smoke Leaf Green Black Brick Raspberry	LENGTH	36"	\$17	\$21	\$26	\$30	\$34	\$43	\$51	\$60	\$68
		48"	\$23	\$28	\$34	\$40	\$46	\$57	\$68	\$80	\$91
		54"	\$26	\$32	\$38	\$45	\$51	\$64	\$77	\$90	\$102
		60"	\$28	\$36	\$43	\$50	\$57	\$71	\$85	\$100	\$114
		66"	\$31	\$39	\$47	\$55	\$63	\$78	\$94	\$110	\$125
		72"	\$34	\$43	\$51	\$60	\$68	\$85	\$102	\$119	\$137
		78"	\$37	\$46	\$55	\$65	\$74	\$92	\$111	\$129	\$148
		84"	\$40	\$50	\$60	\$70	\$80	\$100	\$119	\$139	\$159
		90"	\$43	\$53	\$64	\$75	\$85	\$107	\$128	\$149	\$171
		96"	\$46	\$57	\$68	\$80	\$91	\$114	\$137	\$159	\$182
		108"	\$52	\$64	\$77	\$90	\$102	\$128	\$154	\$179	\$205

		WIDTH									
		24"	30"	36"	42"	48"	60"	72"	84"	96"	
Privacy Liner Privacy Natural Privacy Beige Privacy Chocolate	LENGTH	36"	\$28	\$35	\$42	\$49	\$56	\$70	\$84	\$98	\$112
		48"	\$37	\$47	\$56	\$65	\$75	\$93	\$112	\$131	\$149
		54"	\$42	\$53	\$63	\$74	\$84	\$105	\$126	\$147	\$168
		60"	\$47	\$58	\$70	\$82	\$93	\$117	\$140	\$163	\$187
		66"	\$51	\$64	\$77	\$90	\$103	\$128	\$154	\$180	\$205
		72"	\$56	\$70	\$84	\$98	\$112	\$140	\$168	\$196	\$224
		78"	\$61	\$76	\$91	\$106	\$121	\$152	\$182	\$212	\$243
		84"	\$65	\$82	\$98	\$114	\$131	\$163	\$196	\$229	\$261
		90"	\$70	\$88	\$105	\$123	\$140	\$175	\$210	\$245	\$280
		96"	\$75	\$93	\$112	\$131	\$149	\$187	\$224	\$261	\$299
		108"	\$84	\$105	\$126	\$147	\$168	\$210	\$252	\$294	\$336

		WIDTH									
		24"	30"	36"	42"	48"	60"	72"	84"	96"	
Black-Out Liner Black-Out Soft White Black-Out Beige Black-Out Chocolate	LENGTH	36"	\$36	\$45	\$54	\$63	\$72	\$90	\$108	\$126	\$144
		48"	\$48	\$60	\$72	\$84	\$96	\$120	\$144	\$168	\$192
		54"	\$54	\$68	\$81	\$95	\$108	\$135	\$162	\$189	\$216
		60"	\$60	\$75	\$90	\$105	\$120	\$150	\$180	\$210	\$240
		66"	\$66	\$83	\$99	\$116	\$132	\$165	\$198	\$231	\$264
		72"	\$72	\$90	\$108	\$126	\$144	\$180	\$216	\$252	\$288
		78"	\$78	\$98	\$117	\$137	\$156	\$195	\$234	\$273	\$312
		84"	\$84	\$105	\$126	\$147	\$168	\$210	\$252	\$294	\$336
		90"	\$90	\$113	\$135	\$158	\$180	\$225	\$270	\$315	\$360
		96"	\$96	\$120	\$144	\$168	\$192	\$240	\$288	\$336	\$384
		108"	\$108	\$135	\$162	\$189	\$216	\$270	\$324	\$378	\$432

Clutch Control	24"	30"	36"	42"	48"	60"	72"	84"	96"
	\$90	\$105	\$120	\$130	\$135	\$140	\$150	\$160	\$170

Lined Valance	24"	30"	36"	42"	48"	60"	72"	84"	96"
	\$4	\$4	\$5	\$6	\$6	\$7	\$8	\$9	\$10

Wood Bottom Bar	24"	30"	36"	42"	48"	60"	72"	84"	96"
	\$13	\$16	\$18	\$20	\$22	\$27	\$31	\$36	\$40

Top Down Bottom Up	SURCHARGE FOR ALL SIZES: \$35	Cut Outs	SURCHARGE PER CUT OUT: \$30
--------------------	-------------------------------	----------	-----------------------------

2-on-1 Head Rail	SURCHARGE FOR ALL SIZES: \$35	3-on-1 Head Rail	SURCHARGE FOR ALL SIZES: \$45
------------------	-------------------------------	------------------	-------------------------------

Specifications



Head Rail Dimensions

Middle support brackets will be supplied for all shades over 41 inches wide.

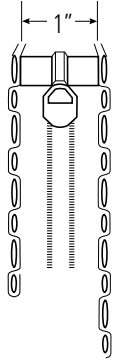

NARROW HEADRAIL

(Custom Order Only)

- Standard Shades
- Waterfall Shades
- TDBU Shades

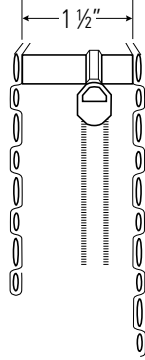

STANDARD HEADRAIL

- Standard Shades
- Waterfall Shades
- TDBU Shades

Size Limitations

Minimum Width: 18 inches
Maximum Width: 96 inches

Minimum Height: 18 inches
Maximum Height: 108 inches

Multiple shades on one head rail can be ordered to 120 inches wide. Maximum width for common valance is 96 inches.

Bracket Dimensions

Height: 1 1/2 inches
Depth: 1 3/4 inches

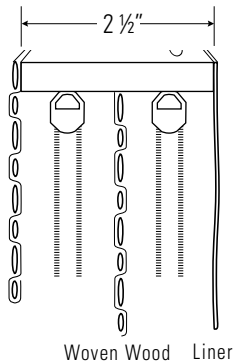
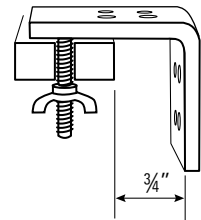
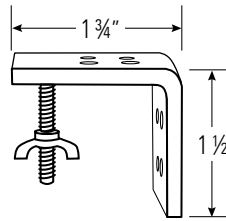

STANDARD TWIN SHADE

Controls Same Side (shown) or Opposite Sides

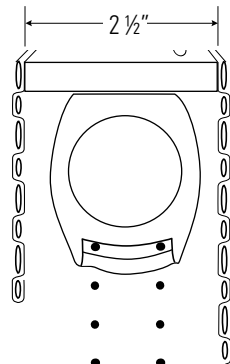

CLUTCH SHADE

With Continuous Cord Loop

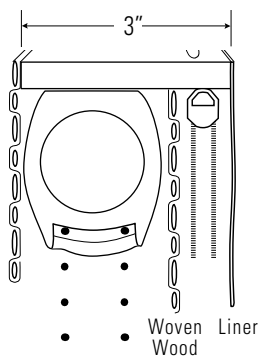

TWIN SHADE WITH CLUTCH

(Clutch Control for Front Shade Only)
Controls Same Side (shown) or Opposite Sides

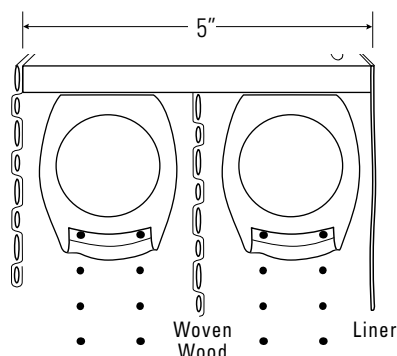

TWIN SHADE WITH 2 CLUTCHES

Controls Same Side (shown) or Opposite Sides

Inside Mount Depths

Minimum Required Depth:

3/4 inch with standard bracket

Flush Mount Depth:

Headrail width plus 1 inch if using standard bracket.

Exact flush inside mount depths will vary slightly based upon the thickness of the fabric.

Inside Mount Deductions

The factory will make a deduction of 3/8 inch for all Inside Mount shades, unless otherwise requested.

Wood Bottom Bar Dimensions

Height: 1 inch
Depth: 1/2 inch

Material is inserted into groove in the top of the wood bottom bar.



One Year Limited Warranty

What is covered by this warranty and for how long:

For a period of one (1) year from the date of purchase, all products are warranted against defects in materials and workmanship provided that the product is installed according to the product instructions. We reserve the right to determine if your piece warrants a repair or partial replacement of any parts or in the unlikely event the entire piece is defective, we will replace this window covering with a new window covering of equal or superior value. This shall be your sole remedy under this warranty.

Who is covered by this warranty:

This warranty applies to the original customer with proof of purchase in a residential application within the United States.

What is not covered in this warranty:

This warranty does not cover removal or installation or reinstallation of any window covering. This warranty does not cover damage or defects caused by or resulting from improper maintenance, neglect or improper use, abuse, misuse, neglect, accidents, Acts of God, alteration, commercial use, installation, removal or reinstallation or exposure to excessive moisture.

Your rights under State Law:

This warranty gives you the specific legal rights. You may also have other rights which may vary from state to state. We will not be liable for **INCIDENTAL OR CONSEQUENTIAL DAMAGES** or for any other direct or indirect damage, loss, cost, expense or fee. Some states do not allow the exclusion or limitation of incidental or consequential damages, so the above limitation or exclusion may not apply to you.

THIS WARRANTY IS EXCLUSIVE AND IN LIEU OF ALL OTHER OBLIGATIONS, LIABILITIES, OR WARRANTIES.