

Vertical Blind Price Catalog

Vinyl, Fabric, and Screen Louvers

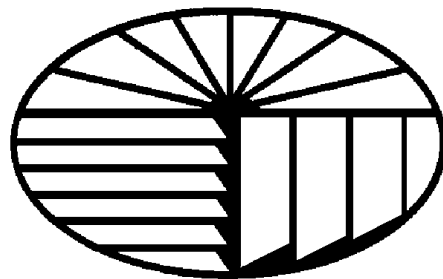

EFFECTIVE JUNE 2011



UNIVERSAL WINDOW COVERINGS, INC.

12139 Science Dr. Suite 101 Orlando, FL 32826

(407) 275-1455 1-800-494-9636 FAX (407) 275-6919 FAX 1-866-872-0672

www.universalwc.com

info@universalwc.com

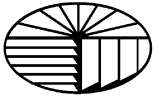

Merchandise Returns — UWC drivers cannot pick up merchandise without prior authorization from Customer Service. Customer Service will provide a Return Goods Authorization number for any return.

- Defective Products—**Please take a picture of any defective material.** This is the easiest and quickest way to solve any problems and helps prevent having the same problem twice. Customer Service will provide direction as to how to proceed.
- Repairs—Customer Service will create a Return Goods Authorization for all repairs, either warranty or non-warranty. Please ensure proper packaging to prevent damage during the return process.

Cancellations—If an order needs to be canceled, please call customer service immediately! We can cancel orders only if the order has not yet gone out to fabrication.

Order Process—UWC requests that all orders are faxed to 407-275-1455 or ordered via email to orders@universalwc.com. Any orders placed over the phone will be at the dealer's responsibility. Customers will normally receive an order confirmation within 24 hours.

Duplicated Orders—UWC cannot be responsible for orders which have been faxed twice. If you must fax an order a second time for any reason, please clearly write "Do Not Duplicate" and refer to the original order with a PO or sidemark to avoid any confusion.

Price Changes—Prices are subject to change without notice.

Delivery Fees—UWC delivers throughout much of the state of Florida for a flat delivery fee of \$12.50 per stop. This fee is subject to change based on a variety of factors. Outside of our delivery area, we charge the cost of UPS or common carrier. COD accounts shipped via UPS will incur a COD charge unless the order is prepaid. Special packaging required for items to be shipped will incur a surcharge of \$2.50 per blind.

Accounts and Payments—

- All new accounts will be set up as COD accounts. To apply for terms, Universal needs to receive the **original** credit application and **we will run references.** This process takes time. Until references are confirmed, we cannot provide credit terms.
- UWC accepts American Express, Mastercard and Visa. We will never charge a credit card without authorization from the cardholder. Accounts have the choice to be set up as a credit card account. This means the cardholder gives Universal blanket permission to charge the card for the merchandise at time of delivery.
- Some contract orders will require a fifty percent deposit.
- Any products ordered on a container require a fifty percent deposit prior to placing the order.
- **Universal will not sell any product to a customer in the state of Florida who does not have a current license to resell the product.** This is to protect you as much as it is to protect us. Customers outside the state of Florida must show a current license to operate a retail business.

Retail Surcharge—Starting in 2011, all of UWC's new price guides will use retail pricing for surcharges. This is done to allow the dealer to use the price guide when making a presentation to the customer. The multiplier is noted in an attached letter.

Vertical Repair Price List

- Cut down standard track - \$15
- Cut down DA1000 track - \$22
- Cut down DA2000 track - \$30
- Refurbish Track - \$15 + parts
- Re-string track - \$15
- Cut down PVC slats - \$10 per blind



Page	Content	Page	Content
2	Terms and Conditions	12	Valance Chart Vertical Valances Faux Wood Valances
2	Vertical Repair Prices		
4	Features and Benefits	13	Completed Track Charts
5	Specifications General Specifications Motorized Specifications	14	Specialty Track Charts Slope Tracks Curved & Arched Tracks Skylight Tracks Top & Bottom Tracks
6	DA1000 Pricing	15	Sunteca Carrier/Stack Chart (1-Way)
7	DA2000 Pricing	16	Sunteca Carrier/Stack Chart (Split)
8	Pattern/Price Grid Chart	17	Measuring Instructions
9	3 1/2" Vertical Charts	18	Installation Instructions
11	3 1/2" Groover for Insert Chart	19	Decomatic Warranty



Vertical Blinds Features and Benefits

For over twenty years, Universal Window Coverings has been distributing only the best products available in the market-place. **Plastibec** offers a vast range of PVC products of which we inventory over **300 SKU's** and provide **weekly deliveries** on our own trucks. Plastibec has many beautiful patented styles which elevates the vertical blind into a wonderful window treatment.

The best PVC line also deserves the best track. For three years, Universal has been fabricating the **Decomatic Track**. The Decomatic track is the most **versatile and longest lasting track** in the industry. With a **lifetime warranty** on the system (2 years on electrical components), you can be confident in the quality of the products you are offering. Decomatic uses only the highest quality materials including stainless steel straps and self lubricating plastic components. The Decomatic track can be bent, arched, motorized, made to put into a skylight or arranged any way you may need a vertical built.

The **DA2000 motor** is powered by a wall transformer and tilts and traverses a vertical blind with the touch of a button. The motor can even be built onto a curved track. The track controlled with a **remote, wall switch, sun sensor or a timer**. The **DA1000 motor** is a battery powered motor which can tilt the blinds while maintaining a streamlined look.

Universal offers several top treatments to finish the verticals. Our award-winning **Cornice Valance** nicely complements the **Executive Valance** line. The two Cornice Valance trims allow for a more **traditional accent coordinating** with the moldings in your room. Executive Valances are built with smart and modern fully rounded corners. Our Executive Valance is available in **single and double profiles**. Universal also offers a new **6" Faux Crown Valance** matching our most popular faux wood horizontals. Clear Edge and 3 1/4" Crown valances are also available.

Fabric Verticals have also come back with a great selection of patterns and colors in our **Evolution** program. A compact book with a beautiful selection is the perfect way to sample these fabrics. Evolution comes standard with free hanging plastic weights and are available with chain and clips upon request.



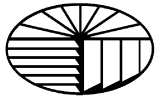

General Specifications

	Decomatic (Standard)	MC-130	8 Prong
Net Minimum Width:	10" (15" for DA2000)	10"	10"
Net Maximum Width:	240" (standard and sloped tracks) Wand Control - 192" Curved Tracks - 220" Skylight Tracks - 178" Top & Bottom Tracks - 154"	192" (not recommended wider than 72")	192" (not recommended wider than 72")
Net Maximum Weight:	65 lbs. Wand Control - 45lbs. Arch - 45 lbs. DA1000 - 27 lbs. Skylight - 6.2 lbs. Top & Bottom - 35 lbs.	Not Available	Not Available
Track Deductions:	IM: 1/4" OM: Exact Measurement	IM: 1/4" OM: Exact Measurement	IM: 1/4" OM: Exact Measurement
Vane Deductions:	IM: 1 7/8" OM: 1 1/2"	IM: 2" OM: 1.5"	IM: 2" OM: 1.5"
Standard Return Length:	IM: 2" OM: 5.5"	IM: 2" OM: 5.5"	IM: 2" OM: 5.5"
Custom Striping (retail):	\$50	\$50	\$50
Cutouts (retail):	\$50 each	\$50 each	\$50 each
Stack Release:	Yes	No	No
Replaceable Stems:	Yes	Yes	No
Wand Availability:	Yes	No	Yes

Motorization (Decomatic Only)

	DA 1000	DA 2000
Function:	Tilt Only	Tilt and Traverse
Power Supply:	Battery (Std) or Transformer	Transformer
Standard Power Cable:	None (72" with optional power supply)	114" (Custom Lengths available)
Control Options:	IR or RF Remote, Wired or RF Wall Switch	IR or RF Remote, Wired or RF Wall Switch, Sun Sensor, Timer, RS 232 Automation
Applications:	Standard, Sloped	All Headrail Systems

CAUTION - When installing DA2000 tracks, plug the jack into the motor prior to plugging into an outlet to prevent permanent motor damage.

Some vertical PVC's have a tendency to emit an odor similar to that of a new pool toy or a shower curtain. This odor is normal, harmless and goes away within 6 to 8 weeks of hanging in a window. This is not considered defective.

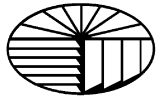

DA1000 Motorization

Type	Description	Retail Price
A	IR Control , Includes: Motor, IR Receiver (Standard) 6 - Channel, IR Remote 6-Channel & Battery Holder	\$514.98
B	IR Control , Includes: Motor, IR Receiver (Remote Eye 18") 6-Channel, IR Remote 6-Channel & Battery Holder	\$549.46
C	RF Control (1-Channel) , Includes: Motor, RF Receiver, RF Electronic Interface, RF Remote 1-Channel & Battery Holder	\$1074.32
D	RF Control (4-Channel) , Includes: Motor, RF Receiver, RF Electronic Interface, RF Remote 4-Channel & Battery Holder	\$1210.24
E	RF Wall Switch Wireless Control (1-Channel) , Includes: Motor, RF Receiver, RF Electronic Interface, RF Wall Switch wireless 1-Channel & Battery Holder	\$1098.56
F	RF Wall Switch Wireless Control (4-Channel) , Includes: Motor, RF Receiver, RF Electronic Interface, RF Wall Switch wireless 4-Channel & Battery Holder	\$1229.60

Power Options

Type	Description	Retail Price
1	Individual Power Supply , Includes: Power Supply, plug in 110V/2A to 6V & Individual Power Supply Cord	\$193.64
2	Power Distribution Box (PDB) , Includes: Power Supply, plug in 110V/6A to 6V, Power Supply Cord, Power Distribution Box & 4 PDB Power Pigtails. This unit will provide power for up to 4 motors.	\$850.85

Individual Components

Type	Description	Retail Price
3	Battery Holder	\$18.12
4	IR Receiver (Standard) 6-Channel	\$126.38
5	IR Receiver (Remote Eye-18") 6-Channel	\$152.90
6	IR Remote 6-Channel	\$76.16
7	RF Receiver	\$ 261.36
8	RF Electronic Interface	\$214.64
9	RF Remote 1-Channel	\$156.80
10	RF Remote 4-Channel	\$ 260.18
11	RF Wall Switch "wireless" 1-Channel	\$175.44
12	RF Wall Switch "wireless" 4-Channel	\$ 276.24
13	Individual Power Supply 110V/2A to 6V	\$229.16
14	Individual Power Supply Cord	\$ 37.90
15	Power Distribution Box (PDB)	\$420.44
16	PDB Power Supply 110V/6A to 6V	\$ 404.92
17	PDB Power Supply Cord	\$ 37.90
18	PDB Power Pigtail	\$161.96
19	PDB Power wire 16/2 - 50ft roll	\$ 80.98



DA2000 Motorization

Type	Description	Retail Price
A	Wall Switch (1-Blind) , Includes: Motor, Wall Switch, Control Cable 78" & Power Supply, plug in 110V to 12v/2a	\$2144.80
B	IR Control , Includes: Motor, Motor Controller, Power Supply, plug in 110V to 12V/2A, IR Receiver in Box with 3ft cable & IR Remote (10-blind)	\$2592.80
C	IR Key Pad Control , Includes: Motor, Motor Controller, Power Supply, plug in 110V to 12V/2A & IR Key Pad (10-Blind)	\$2845.92
D	RF Control , Includes: Motor, Motor Controller, Power Supply, plug in 110V to 12V/2A, RF Receiver with 3ft cable & IR/RF Remote (10-blind)	\$2969.12
E	RF Key Pad Control , Includes: Motor, Motor Controller, Power Supply, plug in 110V to 12V/2A, RF Receiver with 3ft cable & RF Key Pad (10-Blind)	\$3361.12
F	Sun Sensor Control (Interior) , Includes: Motor, Motor Controller, Power Supply, plug in 110V to 12V/2A, Interior Sun Sensor & Interface - Sun & Timer * IR or RF control is recommended for this application (not included)	\$3753.12
G	Sun Sensor Control (Exterior) , Includes: Motor, Motor Controller, Power Supply, plug in 110V to 12V/2A, Exterior Sun Sensor & Interface - Sun & Timer * IR or RF control is recommended for this application (not included)	\$2917.60
H	LCD Timer Control (Dawn/Dusk) , Includes: Motor, Motor Controller, Power Supply, plug in 110V to 12V/2A, LCD Timer (Dawn/Dusk) & Interface - Sun & Timer * IR or RF control is recommended for this application (not included)	\$3085.92

Automation Integration

Type	Description	Retail Price
1	DA2000 RS232 Interface, Needed for all integration projects	\$430.76
2	DA2000 RS232 Interface Adaptor, Used to connect to the RS232 interface from serial to RJ14	\$56.86

Individual Components

Type	Description	Retail Price
3	Power Supply, plug in 110V to 12V/2A	\$ 94.76
4	Wall Switch (1-Blind)	\$ 60.30
5	Control Cable 78"	\$77.54
6	Control Cable 195"	\$ 170.00
7	Control Cable 351"	\$ 241.24
8	IR Receiver in Box with 3ft cable	\$ 63.76
9	IR Receiver - 2ft	\$ 43.08
11	IR Remote (10-Blind)	\$206.76
12	IR Keypad (10 Blind)	\$ 465.24
13	RF Receiver with 3ft cable	\$258.46
14	IR/RF Remote (10-Blind)	\$ 301.54
15	RF Key Pad (10 Blind)	\$ 603.08
16	Interior Sun Sensor	\$ 70.64
17	Exterior Sun Sensor	\$ 175.76
18	LCD Timer Control (Dawn/Dusk)	\$ 292.92
19	Interface - Sun & Timer	\$ 344.62

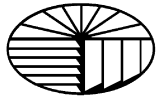

VINYL	FINISH	CHART
Americana	SFT	Chart 6
Artisan	CW	Chart 3
Aspiration	PT	Chart 5
Athens	CW	Chart 3
Aurora	CW	Chart 4
Bamboo	SFT	Chart 6
Biscayne	ENG	Chart 4
Bono	ENG	Chart 3
Bordeaux	SFT	Chart 6
Calypso	EMB	Chart 4
Capri	PE	Chart 6
Cardigan	SFT	Chart 6
Carly	ENG	Chart 3
Concord	CW	Chart 4
Confetti	EMB	Chart 3
Cordova	SFT	Chart 6
Cyndy	ENG	Chart 3
Duo	ENG	Chart 2
Embossed	FW	Chart 3
Fanfare	ENG	Chart 4
Firenza	SFT	Chart 6
Fleur	SFT	Chart 6
Frost	EMB	Chart 3
Herringbone	CW	Chart 4
Infinity	PE	Chart 5
Isabella	PE	Chart 5
Isis	ENG	Chart 4
Island	CW	Chart 4
Laurel	SFT	Chart 6
Leatherby	ENG	Chart 4
Leisurewood	FW	Chart 3
Leisurewood (Printed)	FW	Chart 4
Luxor	PE	Chart 5
Madison	CW	Chart 4
Maestro	STD	Chart 1
Mayfair	ENG	Chart 2
Newbury	EMB	Chart 3
Odessa	ENG	Chart 5
Ovation	STD	Chart 1

VINYL	FINISH	CHART
Oxford	ENG	Chart 4
Palms	EMB	Chart 2
Parisian	SFT	Chart 6
Perforated	STD	Chart 4
Provincial	CW	Chart 5
Rattan	PE	Chart 6
Rome	PT	Chart 6
Rosalie	CW	Chart 4
Sisal	SFT	Chart 6
Splendor	ENG	Chart 4
Stitchbond	EMB	Chart 3
Tempo	ENG	Chart 2
Terrace	CW	Chart 4
Thatch	ENG	Chart 3
Trends	FW	Chart 4
Venice	CW	Chart 4
Vineyard	SFT	Chart 6
Vizcaya	PE	Chart 5
Whimsical	CW	Chart 4
Wicker	CW	Chart 4

FABRIC	CHART
Athenas	Chart 3
Calgary	Chart 8
Cascade	Chart 7
EcoVision 1000	Chart 5
EcoVision 3000	Chart 7
Itaca	Chart 3
Miami	Chart 7
New Liza	Chart 1
Olympic	Chart 3
Quebec	Chart 7
Roma	Chart 4
Toronto	Chart 2
Venice	Chart 5
Vision 314	Chart 8
Vision 351	Chart 8
Vision 550	Chart 8
Vision Crystal 550	Chart 8

Some vertical PVC's using SFT technology have a tendency to emit an odor similar to that of a new pool toy or a shower curtain. This odor is normal, harmless and goes away within 6 to 8 weeks of hanging in a window. This is not considered defective.



Chart 1																				
PVC: Maestro, Ovation -- Fabric: New Liza																				
HEIGHT TO:	37	50	62	75	81	87	100	112	120	131	144	156	169	175	191	203	215	227	240	SLATS ONLY
48	55	65	75	87	94	96	107	116	124	147	160	170	183	191	202	236	246	255	263	1.50
60	59	75	84	96	103	111	121	131	139	163	180	190	208	211	228	265	275	289	298	1.85
72	67	81	95	111	117	124	139	153	165	190	210	220	242	250	267	314	331	343	357	2.16
84	71	86	101	117	124	132	147	162	176	201	224	234	258	266	284	334	351	365	380	2.52
96	75	92	108	125	133	141	157	174	187	211	234	245	270	278	297	357	375	390	405	2.88
108	87	107	126	147	157	166	187	206	221	252	278	294	321	331	358	429	448	467	487	3.49
120	91	113	134	157	167	178	200	221	237	270	297	315	343	354	383	460	481	502	523	3.88
Addl. 12"	8	8	10	11	12	13	15	17	18	20	22	23	24	26	28	31	35	38	42	0.50

Valance pricing is not included in the vertical chart. Please refer to the valance chart on page 12 for valance pricing.

Chart 2																				
PVC: Duo, Mayfair, Palms, Tempo -- Fabric: Toronto																				
HEIGHT TO:	37	50	62	75	81	87	100	112	120	131	144	156	169	175	191	203	215	227	240	SLATS ONLY
48	60	72	84	97	105	108	120	131	142	168	181	192	207	217	231	270	282	292	302	1.78
60	66	85	97	110	118	127	139	151	160	188	208	221	242	244	265	308	321	337	348	2.32
72	76	93	111	129	138	146	164	181	196	223	249	261	287	297	317	374	393	410	427	2.89
84	80	99	117	137	146	155	173	192	208	237	265	277	306	315	336	397	418	436	453	3.37
96	86	105	125	146	156	166	185	205	222	249	278	290	320	330	353	424	446	464	484	3.85
108	101	125	150	174	186	199	223	248	265	303	334	354	386	399	432	519	541	566	590	4.67
120	106	133	159	187	200	213	240	266	286	326	359	382	416	430	465	559	584	611	638	5.18
Addl. 12"	8	9	11	14	15	16	18	20	22	24	26	27	29	31	33	36	40	43	47	0.75

Valance pricing is not included in the vertical chart. Please refer to the valance chart on page 12 for valance pricing.

Chart 3																				
PVC: Artisan, Athens, Bono, Carly, Confetti, Cyndy, Embossed, Frost, Leisurewood (Whites/Embossed), Newbury, Stitchbond, Thatch -- Fabric: Athenas, Itaca, Olympic																				
HEIGHT TO:	37	50	62	75	81	87	100	112	120	131	144	156	169	175	191	203	215	227	240	SLATS ONLY
48	72	88	101	116	127	131	144	160	171	191	207	222	238	250	267	310	326	339	350	2.52
60	79	102	115	133	142	153	167	183	195	218	243	258	283	287	312	361	376	398	410	3.28
72	94	116	136	159	169	179	200	222	241	268	299	313	346	357	382	450	475	496	518	4.09
84	96	119	141	164	175	187	211	232	253	284	318	333	368	380	405	479	505	527	549	4.77
96	102	127	150	175	187	200	223	248	272	297	334	349	385	398	424	510	538	562	586	5.45
108	118	148	179	210	225	240	270	301	323	368	407	432	472	488	528	636	663	695	726	6.60
120	127	159	193	226	242	260	292	326	349	398	441	469	512	529	573	690	720	755	790	7.33
Addl. 12"	9	11	14	16	17	20	22	24	26	28	31	34	37	41	45	50	55	60	65	1.00

Valance pricing is not included in the vertical chart. Please refer to the valance chart on page 12 for valance pricing.

Fabric verticals are made free hanging unless otherwise specified.

For fabrics inserted into Groover, add the cost for the fabric vertical to the "Groover Surcharge" chart and take discount from the total.

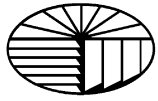

Chart 4																				
PVC: Aurora, Biscayne, Calypso, Concord, Fanfare, Herringbone, Isis, Island, Leatherby, Leisurewood (Printed), Madison, Oxford, Perforated, Rosalie, Splendor, Terrace, Trends, Venice, Whimsical, Wicker -- Fabric: Roma																				
HEIGHT																				SLATS
TO:	37	50	62	75	81	87	100	112	120	131	144	156	169	175	191	203	215	227	240	ONLY
48	75	93	108	126	138	141	157	174	187	214	231	247	267	280	299	349	366	381	395	2.98
60	85	111	127	144	157	169	185	202	215	246	275	292	321	324	354	408	427	453	466	3.88
72	100	124	145	170	185	195	220	245	270	307	344	359	398	412	439	518	547	572	597	4.84
84	104	130	157	183	196	209	236	261	285	326	365	382	422	436	466	551	580	608	634	5.65
96	112	139	167	195	209	224	251	279	305	341	383	399	442	458	488	587	620	647	676	6.45
108	134	170	205	241	259	277	313	348	373	426	472	501	549	567	614	738	771	808	847	7.82
120	143	183	222	261	281	300	338	377	405	462	512	545	596	616	667	803	839	880	922	8.68
Addl. 12"	11	13	16	19	22	25	29	32	35	38	41	44	47	50	54	59	64	70	75	1.15

Valance pricing is not included in the vertical chart. Please refer to the valance chart on page 12 for valance pricing.

Chart 5																				
PVC: Aspiration, Infinity, Isabella, Luxor, Odessa, Provincial, Vizcaya -- Fabric: EcoVision 1000, Venice																				
HEIGHT																				SLATS
TO:	37	50	62	75	81	87	100	112	120	131	144	156	169	175	191	203	215	227	240	ONLY
48	80	101	117	137	152	154	173	191	207	243	262	282	304	320	342	399	420	438	456	4.00
60	92	122	140	160	175	191	209	228	245	286	322	341	377	379	416	480	501	535	553	5.21
72	114	144	173	205	220	235	266	296	324	369	416	434	483	499	533	630	665	698	731	6.50
84	119	152	184	217	233	249	282	314	344	392	443	462	513	531	567	670	707	741	777	7.59
96	128	162	196	231	248	266	301	335	367	410	464	484	537	555	594	714	754	792	828	8.67
108	158	203	247	293	316	338	382	427	460	525	584	620	679	702	762	917	957	1007	1056	10.50
120	171	221	269	320	344	368	418	467	503	573	638	678	743	769	834	1004	1048	1103	1158	11.67
Addl. 12"	13	17	21	25	29	33	37	40	44	48	53	57	61	65	69	74	79	84	90	1.45

Valance pricing is not included in the vertical chart. Please refer to the valance chart on page 12 for valance pricing.

Chart 6																				
PVC: Americana, Bamboo, Bordeaux, Capri, Cardigan, Cordova, Firenze, Fleur, Laurel, Parisian, Rattan, Rome, Sisal, Vineyard																				
HEIGHT																				SLATS
TO:	37	50	62	75	81	87	100	112	120	131	144	156	169	175	191	203	215	227	240	ONLY
48	89	112	132	155	172	175	196	218	236	279	303	325	350	370	395	460	485	505	527	4.96
60	104	141	162	185	203	221	242	263	282	331	371	394	436	439	480	555	580	619	640	6.46
72	132	169	203	240	257	274	308	345	378	427	482	503	559	578	618	730	771	808	847	8.06
84	137	175	212	251	270	288	326	363	399	453	512	534	594	614	656	775	818	859	899	9.41
96	147	187	226	268	287	308	347	388	425	476	536	560	622	642	687	826	874	916	960	10.75
108	182	235	286	340	365	391	443	495	533	608	676	718	787	815	883	1064	1110	1168	1225	13.02
120	198	255	312	371	399	427	484	541	584	665	740	787	861	892	967	1165	1216	1279	1344	14.47
Addl. 12"	14	19	24	29	34	38	42	49	53	59	64	70	75	80	84	90	97	105	115	1.75

Valance pricing is not included in the vertical chart. Please refer to the valance chart on page 12 for valance pricing.

Fabric verticals are made free hanging unless otherwise specified.

For fabrics inserted into Groover, add the cost for the fabric vertical to the "Groover Surcharge" chart and take discount from the total.

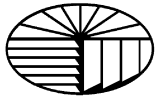

Chart 7																				
Fabric: Cascade, EcoVision 3000, Miami, Quebec																				
HEIGHT																				SLATS ONLY
TO:	37	50	62	75	81	87	100	112	120	131	144	156	169	175	191	203	215	227	240	
48	94	118	139	163	181	184	206	229	248	293	319	342	368	389	415	483	510	531	554	5.70
60	110	149	171	195	214	233	255	277	297	348	390	414	458	461	504	583	609	650	672	7.43
72	139	178	214	252	270	288	324	363	397	449	507	529	587	607	649	767	810	849	890	9.27
84	144	184	223	264	284	303	343	382	419	476	538	561	624	645	689	814	859	902	944	10.82
96	155	197	238	282	302	324	365	408	447	500	563	588	654	675	722	868	918	962	1008	12.36
108	192	247	301	357	384	411	466	520	560	639	710	754	827	856	928	1118	1166	1227	1287	14.97
120	208	268	328	390	419	449	509	569	614	699	777	827	905	937	1016	1224	1277	1343	1412	16.64
Add. 12"	16	21	27	31	37	43	46	52	59	64	70	75	80	85	91	98	105	112	120	2.10

Valance pricing is not included in the vertical chart. Please refer to the valance chart on page 12 for valance pricing.

Chart 8																				
Fabric: Calgary, Vision 314, Vision351, Vision 550, Vision Crystal 550																				
HEIGHT																				SLATS ONLY
TO:	37	50	62	75	81	87	100	112	120	131	144	156	169	175	191	203	215	227	240	
48	108	136	160	187	208	212	237	263	285	337	367	393	423	447	477	555	587	611	637	6.84
60	127	171	197	224	246	268	293	319	342	400	449	476	527	530	580	670	700	748	773	8.91
72	160	205	246	290	311	331	373	417	457	516	583	608	675	698	746	882	932	976	1024	11.12
84	166	212	256	304	327	348	394	439	482	547	619	645	718	742	792	936	988	1037	1086	12.99
96	178	227	274	324	347	373	420	469	514	575	647	676	752	776	830	998	1056	1106	1159	14.84
108	221	284	346	411	442	473	536	598	644	735	817	867	951	984	1067	1286	1341	1411	1480	17.97
120	239	308	377	449	482	516	585	654	706	804	894	951	1041	1078	1168	1408	1469	1544	1624	19.97
Add. 12"	18	26	30	36	42	49	54	61	66	71	78	86	92	100	105	112	121	128	140	2.40

Valance pricing is not included in the vertical chart. Please refer to the valance chart on page 12 for valance pricing.

Groover Surcharge																				
HEIGHT																				SLATS ONLY
TO:	37	50	62	75	81	87	100	112	120	131	144	156	169	175	191	203	215	227	240	
48	23	30	37	45	52	52	60	67	74	82	89	96	104	111	119	126	133	141	148	2.52
60	30	45	52	60	67	74	82	89	96	104	119	126	141	141	155	163	170	185	192	3.28
72	44	59	73	88	95	102	117	131	146	153	175	182	204	211	226	240	255	269	284	4.09
84	51	68	84	101	110	118	135	152	168	177	202	210	235	244	261	277	294	311	328	4.77
96	55	74	92	110	119	129	147	165	184	193	220	229	257	266	284	303	321	339	357	5.45
108	68	90	113	135	147	158	180	203	220	236	264	281	309	321	349	371	388	410	433	6.60
120	75	100	125	150	163	175	200	225	244	263	294	312	344	356	387	412	431	456	481	7.33
Add. 12"	9	11	14	16	17	20	22	24	26	28	31	34	37	41	45	50	55	60	65	1.00

Fabric verticals are made free hanging unless otherwise specified.

For fabrics inserted into Groover, add the cost for the fabric vertical to the "Groover Surcharge" chart and take discount from the total.



Vertical Valances																			
HEIGHT TO:	37	50	62	75	81	87	100	112	120	131	144	156	169	175	191	203	215	227	240
Ultra-RS	16	18	21	23	26	27	29	31	34	36	41	43	46	47	50	55	61	68	76
Sgl. Executive	45	53	61	68	76	80	84	92	99	104	119	127	135	138	148	160	175	192	212
DbL. Executive	58	69	82	93	106	112	117	130	141	149	172	183	196	202	217	235	258	282	312
Cornice	50	59	68	75	84	88	93	102	109	115	131	140	149	152	163	176	193	212	234

Faux Wood Valances (Retail)

6" Crown Valance with Dust Cap: \$13.00/ft
6" Crown Valance w/o dust cap: \$8.00/ft

3 1/4" Crown Valance with Dust Cap: \$8.70/ft
3 1/4" Crown Valance w/o dust cap: \$4.00/ft

Valances greater than their respective specifications will have a mitered seam in the middle unless otherwise specified.

Vertical Valances: 191"

6" Crown Valances: 118"

3 1/4" Crown Valance: 106"



(Double Executive Valance)

Executive Valance

Smart and modern with fully rounded corners, the Executive Valance adds the finishing touch to your vertical blind. This innovative product is a decorative window accessory which covers the blind headrail and is available in a single or double profile.

Executive Trims

- Black Satin
- White
- Denim
- Dark Walnut
- Sage
- Light Oak
- Blush
- Chrome
- Lilac
- Gold

Tuscany Trims

- Cocoa Silk
- Pearl Rose
- Emerald
- Pewter
- Steel Blue
- Golden Cream
- Aubergine
- White
- Muscadet



Cornice Valance

The award winning Cornice Valance is used to decorate vertical and horizontal blinds. The two cornice valance trims; Renaissance and Colonial allow for a more traditional accent coordinating with the moldings in your room. The two profiles can be mixed or matched on the same valance. (vertical and horizontal blinds)

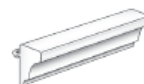

Renaissance Cornice Trim



Colonial Cornice Trim



DECOMATIC TRACK	
WIDTH	RETAIL
36	42.12
42	45.12
48	50.22
54	53.2
60	56.2
66	58.8
72	61.8
78	67.58
84	72.82
90	75.92
96	81.6
102	86.2
108	91.72
114	94.96
120	98.22
126	102.22
132	107.24
138	112.86
144	116.16
150	121.08
156	128.88
162	135.58
168	144.24
174	150.62
180	157.26
186	164.16
192	171.34
198	197.74
204	207.7
210	217.06
216	226.86
222	237.14
228	251.34
234	262.78
240	274.14

3 Prong & 8 Prong Tracks	
WIDTH	RETAIL
36	33.10
42	35.26
48	38.22
54	40.38
60	42.54
66	44.88
72	48.96
78	53.04
84	57.12
90	61.20
96	65.28
102	69.36
108	73.44
114	77.52
120	81.60
126	85.68
132	89.76
138	93.84
144	97.92
150	102.00
156	106.08
162	110.16
168	114.24
174	118.32
180	122.40
186	126.48
192	130.56

*3 Prong / 8 Prong tracks are not recommended for widths greater than 72" due to performance issues



Curved tracks have a minimum radius of 26"

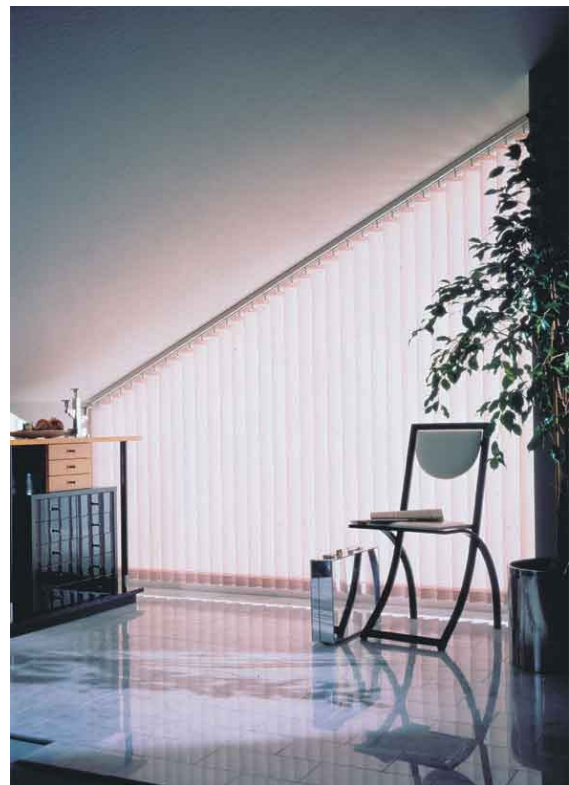

Sloped tracks have a max. angle of 55° (64° by cutting the corner of the slat)

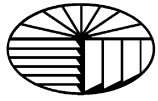

Slope Tracks	
Width	Retail
34"	\$115.41
40"	\$135.78
46"	\$156.15
52"	\$176.51
58"	\$196.88
64"	\$217.25
70"	\$237.61
76"	\$257.98
82"	\$278.35
88"	\$298.71
94"	\$319.08
100"	\$339.45
106"	\$359.81
112"	\$380.18
118"	\$400.55
124"	\$420.91
130"	\$441.28
136"	\$461.65
142"	\$482.01
148"	\$502.38
154"	\$522.75
160"	\$543.11
166"	\$563.48
172"	\$583.85
178"	\$604.21
184"	\$624.58
190"	\$644.95
196"	\$665.31
202"	\$685.68
208"	\$706.05
214"	\$726.41
220"	\$746.78
226"	\$767.15
232"	\$787.52
238"	\$807.88
240"	\$814.67

Curved & Arch Tracks	
Width	Retail
34"	\$353.27
40"	\$415.61
46"	\$477.95
52"	\$540.29
58"	\$602.63
64"	\$664.97
70"	\$727.31
76"	\$789.65
82"	\$851.99
88"	\$914.33
94"	\$976.67
100"	\$1,039.02
106"	\$1,101.36
112"	\$1,163.70
118"	\$1,226.04
124"	\$1,288.38
130"	\$1,350.72
136"	\$1,413.06
142"	\$1,475.40
148"	\$1,537.74
154"	\$1,600.08
160"	\$1,662.42
166"	\$1,724.77
172"	\$1,787.11
178"	\$1,849.45
184"	\$1,911.79
190"	\$1,974.13
196"	\$2,036.47
202"	\$2,098.81
208"	\$2,161.15
214"	\$2,223.49
220"	\$2,285.83

Arch height cannot exceed one quarter of base line width.

Skylight Tracks	
Width	Retail
34"	\$298.20
40"	\$350.82
46"	\$403.44
52"	\$456.06
58"	\$508.69
64"	\$561.31
70"	\$613.93
76"	\$666.56
82"	\$719.18
88"	\$771.80
94"	\$824.42
100"	\$877.05
106"	\$929.67
112"	\$982.29
118"	\$1,034.91
124"	\$1,087.54
130"	\$1,140.16
136"	\$1,192.78
142"	\$1,245.41
148"	\$1,298.03
154"	\$1,350.65
160"	\$1,403.27
166"	\$1,455.90
172"	\$1,508.52
178"	\$1,561.14

Skylight tracks must be made using fabric slats.

Top & Bottom Tracks	
Width	Retail
34"	\$270.66
40"	\$318.42
46"	\$366.19
52"	\$413.95
58"	\$461.72
64"	\$509.48
70"	\$557.24
76"	\$497.62
82"	\$536.91
88"	\$576.20
94"	\$615.48
100"	\$654.77
106"	\$694.06
112"	\$733.34
118"	\$772.63
124"	\$811.91
130"	\$851.20
136"	\$890.49
142"	\$929.77
148"	\$969.06
154"	\$1,008.34

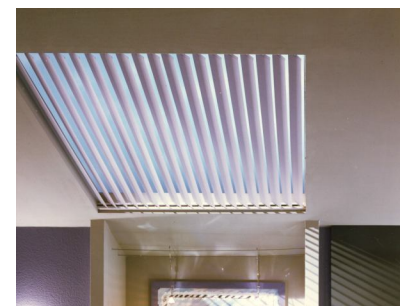

Additional freight charges will apply



Sunteca Track System

of Carriers & Stack Width

One-Way

# of Slats	Width	Stack
3	10"	3"
4	13.125"	3.25"
5	16.25"	3.625"
6	19.375"	3.875"
7	22.5"	4.25"
8	25.5"	4.5"
9	28.625"	4.875"
10	31.374"	5.125"
11	34.875"	5.5"
12	38"	5.75"
13	41.125"	6.125"
14	44.25"	6.375"
15	47.375"	6.75"
16	50.375"	7"
17	53.5"	7.375"
18	56.625"	7.625"
19	59.75"	8"
20	62.875"	8.25"
21	66"	8.625"
22	69.125"	8.875"
23	72.25"	9.25"
24	75.25"	9.5"
25	78.375"	9.875"
26	81.5"	10.125"
27	84.625"	10.5"

# of Slats	Width	Stack
28	87.75"	10.75"
29	90.875"	11.125"
30	94"	11.375"
31	97.125"	11.75"
32	100.25"	12"
33	103.625"	12.375"
34	106.375"	12.625"
35	109.5"	13"
36	112.625"	13.25"
37	115.75"	13.625"
38	118.875"	13.875"
39	122"	14.25"
40	125.125"	14.5"
41	128.125"	14.875"
42	131.25"	15.125"
43	134.375"	15.5"
44	137.5"	15.75"
45	140.625"	16.125"
46	143.75"	16.375"
47	146.875"	16.75"
48	150"	17"
49	153.125"	17.375"
50	156.125"	17.625"
51	159.25"	18"
52	162.375"	18.25"

# of Slats	Width	Stack
53	165.5"	18.625"
54	168.625"	18.875"
55	171.75"	19.25"
56	174.875"	19.5"
57	178"	19.875"
58	181"	20.125"
59	184.125"	20.5"
60	187.25"	20.75"
61	190.375"	21.125"
62	193.5"	21.375"
63	196.625"	21.75"
64	199.75"	22"
65	202.875"	22.375"
66	206"	22.625"
67	209"	23"
68	212.125"	23.25"
69	215.25"	23.625"
70	218.375"	23.875"
71	221.5"	24.25"
72	224.625"	24.5"
73	227.75"	24.875"
74	230.875"	25.125"
75	233.875"	25.5"
76	237"	25.75"
77	240"	26.125"



Sunteca Track System # of Carriers & Stack Width Split

# of Slats	Width	Stack Per Side
4	12.50	2.625
6	18.75	3
8	25	3.25
10	31.125	3.625
12	37.375	3.875
14	43.625	4.25
16	49.875	4.5
18	56	4.875
20	62.25	5.125
22	68.5	5.5
24	74.75	5.75
26	81	6.125
28	87.125	6.375
30	93.375	6.75
32	99.625	7
34	105.875	7.375
36	112	7.625
38	118.25	8
40	124.5	8.25

# of Slats	Width	Stack Per Side
42	130.75	8.625
44	136.875	8.875
46	143.125	9.25
48	149.375	9.5
50	155.625	9.875
52	161.75	10.125
54	168	10.5
56	174.25	10.75
58	180.5	11.125
60	186.75	11.375
62	192.875	11.75
64	199.125	12
66	205.375	12.375
68	211.625	12.625
70	217.75	13
72	224	13.25
74	230.25	13.625
76	236.5	13.875
78	240	14.25



Measuring and Installation Instructions

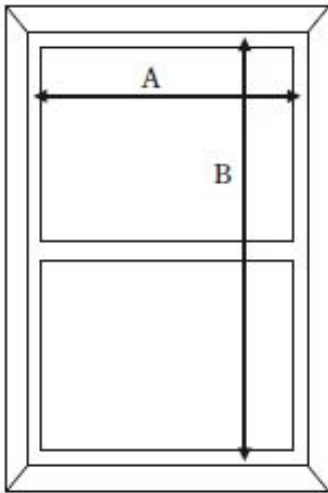

Inside Mount:

A/B - Measure the exact width and height of the window opening in at least three places. Use the smallest dimension in each direction as the ordering size.

Take no deductions. The factory will take all necessary allowances.. Note: you must place the order marked as inside mount to ensure the proper deductions are taken at the factory.

Outside Mount:

A/B - Measure the exact width and height of the area to be covered.

On outside mount measurements, the factory will produce your verticals to your exact sizes.

*Please check the stack charts on pages 15 & 16 for stack coverage.

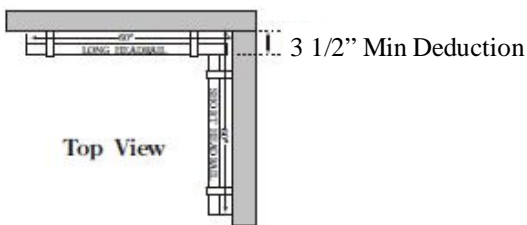
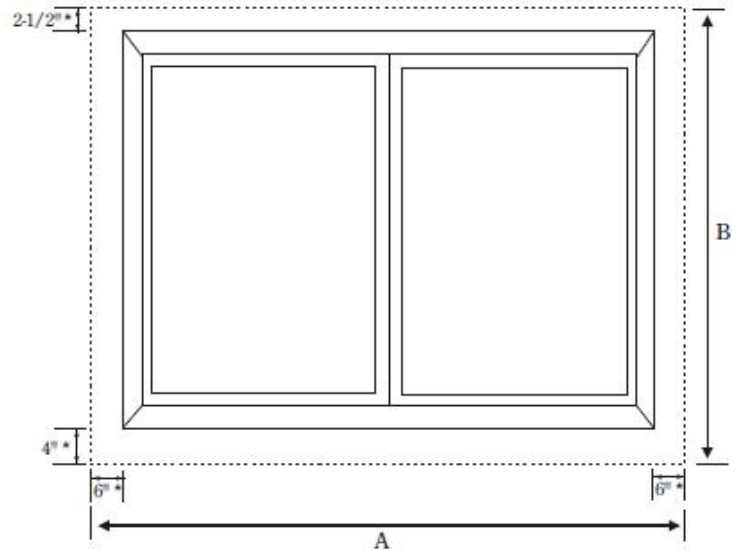

Top View

Corner Measurements:

Measure both units separately. Deduct 3 1/2" plus the necessary allowance for any obstruction (window sill, window crank, etc.) from the short unit.

Example: The two units to the right each measure 60" wide. The long unit will be made 60" wide and the short unit will be made 56 1/2" wide.

*Either unit may be designated as the "short" unit.

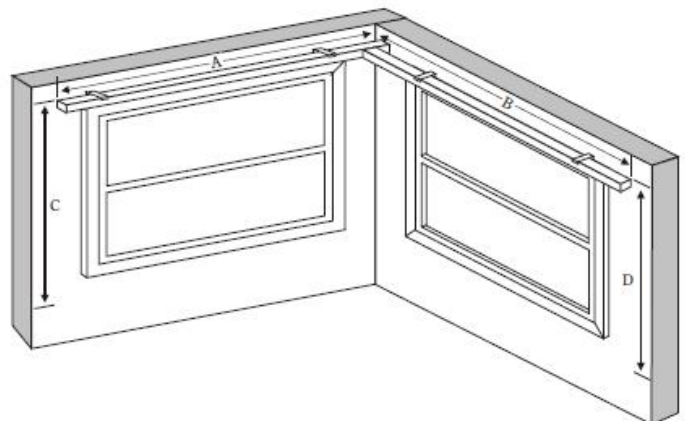



Install the Brackets:

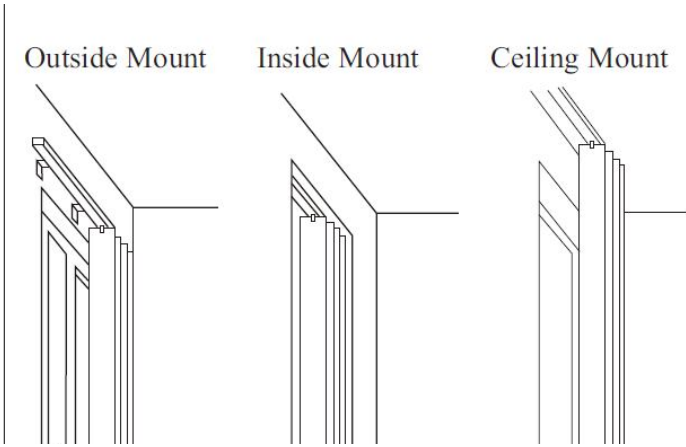

Inside/Ceiling Mount:

Use mounting clips to secure headrail on ceiling or inside mounts.

The center of the mounting clips correspond to the center of the louver.

Position the screws a minimum of 2 1/4" in front of the window frame or any obstruction.

Mounting clips will be spaced approximately 24" apart from each other.

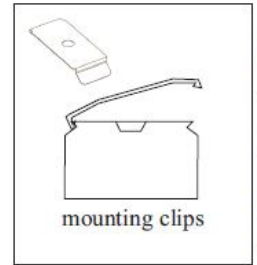

Outside Mount:

Standard wall brackets are adjustable and provide 1/2" to 1 1/2" wall clearance.

Determine the height for the top bracket by adding 1/2" to the blind height including the headrail. This will allow for a 1/2" clearance for the louvers.

Place the first bracket directly above the corner of the window with approximately 24" space between the brackets. Adjust brackets to ensure clearance beyond all obstructions.

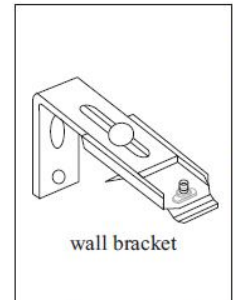

Hang the Track:

Place the front of the track inside the front lip of the bracket then snap the track straight up. Ensure the track is properly secured to all mounting clips.

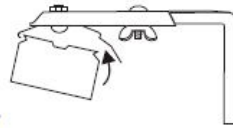

Attach the Vanes:

Push the louvers up into the carrier stem and pull down to ensure the louver hangs freely on the bottom hook.

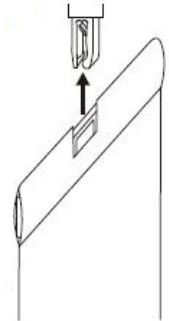

Test The Track:

Pull the cord to verify the track traverses smoothly in both directions.

*Ensure the vanes are in the open position while traversing.

With the blinds traversed closed, rotate the vanes by using the chain to verify smooth rotation.

Top It Off:

Inside/Ceiling Mount:

Attach the clip to the valance cover directly onto the mounting surface as shown.

Outside Mount:

Attach valance holders evenly across the track and slide the dust cover into the groove.

Attach the included returns using the square corner as indicated at left.

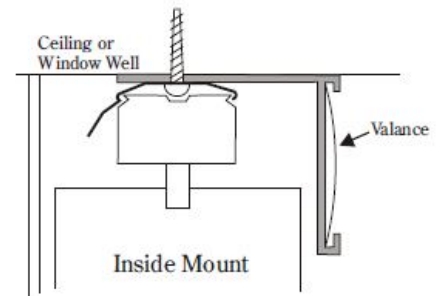
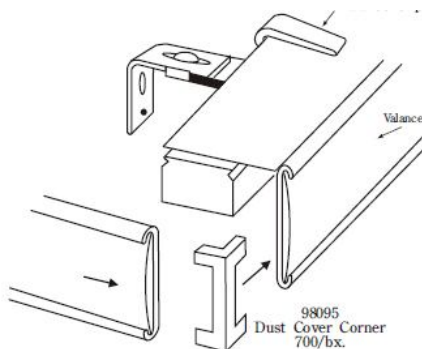



Decomatic Warranty

Universal Window Coverings, Inc. ("Company") warrants that its products will be free from defects in materials and workmanship, under normal use and service and subject to the conditions set forth below, for the following respective time periods:

HEAD RAIL: LIFETIME LIMITED WARRANTY

Company warrants that its Head rail sold hereunder will substantially conform to the applicable specifications and will be free from defects in material and workmanship for the life of the Head rail, under normal and proper use and service.

BLIND VANES: 3 YEAR LIMITED WARRANTY

Company warrants that its blind louvers sold hereunder will substantially conform to the applicable specifications and will be free from defects in material and workmanship for a period of three (3) years after date of purchase, under normal and proper use and service.

ELECTRICAL COMPONENTS: 2 YEAR LIMITED WARRANTY

Company warrants that its electrical components sold hereunder will substantially conform to the applicable specifications and will be free from defects in material and workmanship for a period of two(2) years after date of purchase, under normal and proper use and service.

WARRANTY LIMITATION. This limited warranty and remedies for breach of warranty extend only to the ultimate owner at the original site of installation and do not cover, and Company shall not be liable for, (i) abnormal wear and tear or damage caused by improper installation, maintenance or use contrary to the instructions published by Company (ii) storage of Products in a wet or damp area or unprotected from weather and other job conditions (iii) any cause beyond the control of Company, including without limitation conditions caused by movement, settlement or structural defects of building in which the Products are installed, fire, wind, hail, flood, lightning or other acts of God, intentional acts, accidents, negligence or exposure to harmful chemicals, pollutants or other foreign matter or energy, or (iv) repair of damage caused by anyone except personnel authorized by Company. Products repaired or replaced and designs corrected under warranty are warranted only for the remainder of the original warranty period if a time limitation has been give. Any general product literature is for illustrative purposes only and does not amount to a warranty of any kind. Purchaser accepts full responsibility for the selection of the Products to achieve intended results.

THIS LIMITED WARRANTY AS SET FORTH HEREIN IS STRICTLY Limited TO ITS TERMS AND IS IN LIEU OF ALL OTHER WARRANTIES, GUARANTEES, EXPRESS OR IMPLIED, ARISING BY OPERATION OF LAW, COURSE OF DEALING, USAGE OF TRADE OR OTHERWISE, ANY IMPLIED WARRANTIES INCLUDING BUT NOT LIMITED TO ANY IMPLIED WARRANTIES OF MERCHANTABILITY OR FITNESS FOR A PARTICULAR PURPOSE SHALL BE LIMITED IN DURATION TO THE WARRANTY PERIODS OF TIME SET FORTH ABOVE.

REMEDY. PURCHASER'S SOLE AND EXCLUSIVE REMEDY UNDER THIS LIMITED WARRANTY OR ANY (INCLUDING ANY IMPLIED WARRANTY), AND COMPANY'S ONLY OBLIGATION FOR BREACH OF WARRANTY FOR PRODUCTS FURNISHED HEREUNDER, SHALL BE, AT COMPANY'S OPTION, TO REPAIR OR REPLACE THE DEFECTIVE ITEM(S) OR PART(S) WHICH FAIL WITHIN THE DESIGNATED WARRANTY TIME PERIOD, FREE OF CHARGE, provided that Purchaser promptly give notice, but not later that 30 days after defect(s) is discovered, to Company of such failure. In the event Purchaser claims that the Products are defective, Purchaser must return such Products to Company to examine the Products to determine if such Products are defective. In addition, upon Company's request, Purchaser must allow Company's personnel access and permission to inspect the Products at the site of installation or use. NOTWITHSTANDING THIS WARRANTY, UNDER ALL CIRCUMSTANCES, PURCHASER IS RESPONSIBLE FOR THE COSTS OF REMOVAL, INSTALLATION OR REINSTALLATION OF THE PRODUCT.

DISCLAIMER: LIMITATION OF LIABILITY TIME FOR CLAIMS. Purchaser understands and agrees that COMPANY SHALL NOT BE LIABLE FOR INCIDENTAL, SPECIAL, INDIRECT OR CONSEQUENTIAL OR OTHER SIMILAR DAMAGES including but not limited to loss of profit or revenues, damage for loss of the use of the products, damages due to delay, damage to property, claims of third parties, including personal injury or death suffered as a result of use of products of failure of Company to warn, or to adequately warn, against the dangers of the products or to instruct, or adequately instruct, about the safe and proper use of the products, whether or not the Company has been advised to the potential for such damages. The total liability, will be limited to the lesser of Purchaser's actual damages or the purchase price paid to Company of the products that are the subject of Purchaser's claim. However, this limitation of liability does not apply to damages resulting from personal injury caused by Company's negligence. All claims against Company must be brought within one year after the cause of action arises, and Purchaser expressly waives any statute of limitations which might apply by operation of law or otherwise.

COMPANY SHALL NOT BE LIABLE FOR ANY DAMAGE OR PENALTIES WHATSOEVER, WHETHER, DIRECT, INDIRECT, INCIDENTAL, SPECIAL OR CONSEQUENTIAL, FOR ACTIONS AND OMISSIONS RESULTING FROM COMPANY'S FAILURE TO DELIVER OR DELAY IN DELIVERY FOR ANY REASON.

CLAIMS FOR WARRANTY SERVICE

To obtain warranty service, Purchaser must notify company and the dealer which sold the product in writing of the nature of the problem. In the written notice, Purchaser must include its name, address, telephone number, a description of the problem and the date on which the problem first occurred. A bill of sale, canceled check, receipt or other proof of purchase also must be provided to verify the date of purchase and the identity of the Purchaser. In some cases, Company may require Purchaser to ship the defective part(s), transportation or other related charges prepaid, to the nearest warranty service factory location. Purchaser must contact Company and the dealer that sold the Product as soon as possible, but not later that 30 days, after the defect(s) is discovered. If Purchaser has any problems with or questions about warranty service, please write Universal Window Coverings, Inc. at 12139 Science Drive, Orlando, FL 32826.

REPLACEMENT PARTS. Replacement parts supplied by Company under this Limited Warranty are not warranted.

RESALE OF PRODUCTS. Upon resale of any Products sold hereunder, Purchaser agrees to extend to its customers no greater warranties than those contained herein and limit its liability and remedies to the same extent as those set forth herein.

SEPARABILITY; INVALIDITY. If any portion of this Limited Warranty shall for any reason be held by a court of competent jurisdiction to be invalid and unenforceable, the valid and enforceable provisions will continue to be given effect and bind parties hereto.

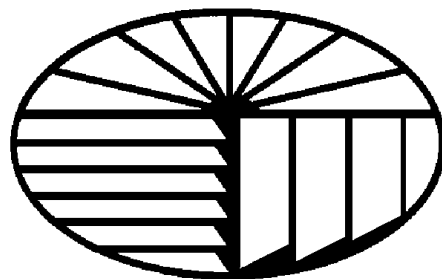

UNIVERSAL WINDOW COVERINGS, INC.

12139 Science Dr. Suite 101 Orlando, FL 32826

(407) 275-1455 1-800-494-9636 FAX (407) 275-6919 FAX 1-866-872-0672

www.universalwc.com